

A a

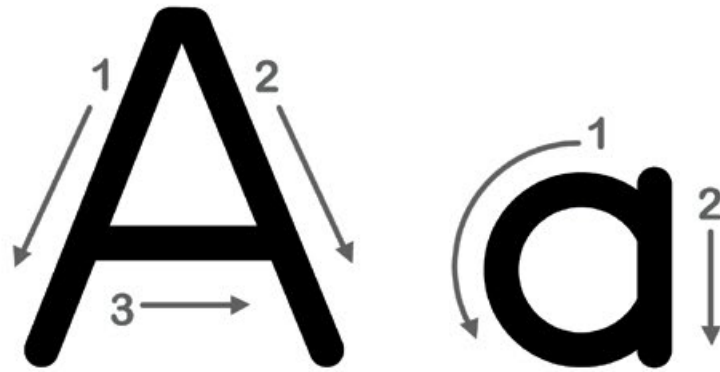

Aap

Oefen om te skryf



A A A

d d d

Aap

**Vind al die A's en a's
en kleur hulle in!**

E

A

D

a

A

b

A

d

C

a

B

c

e

a

Bb

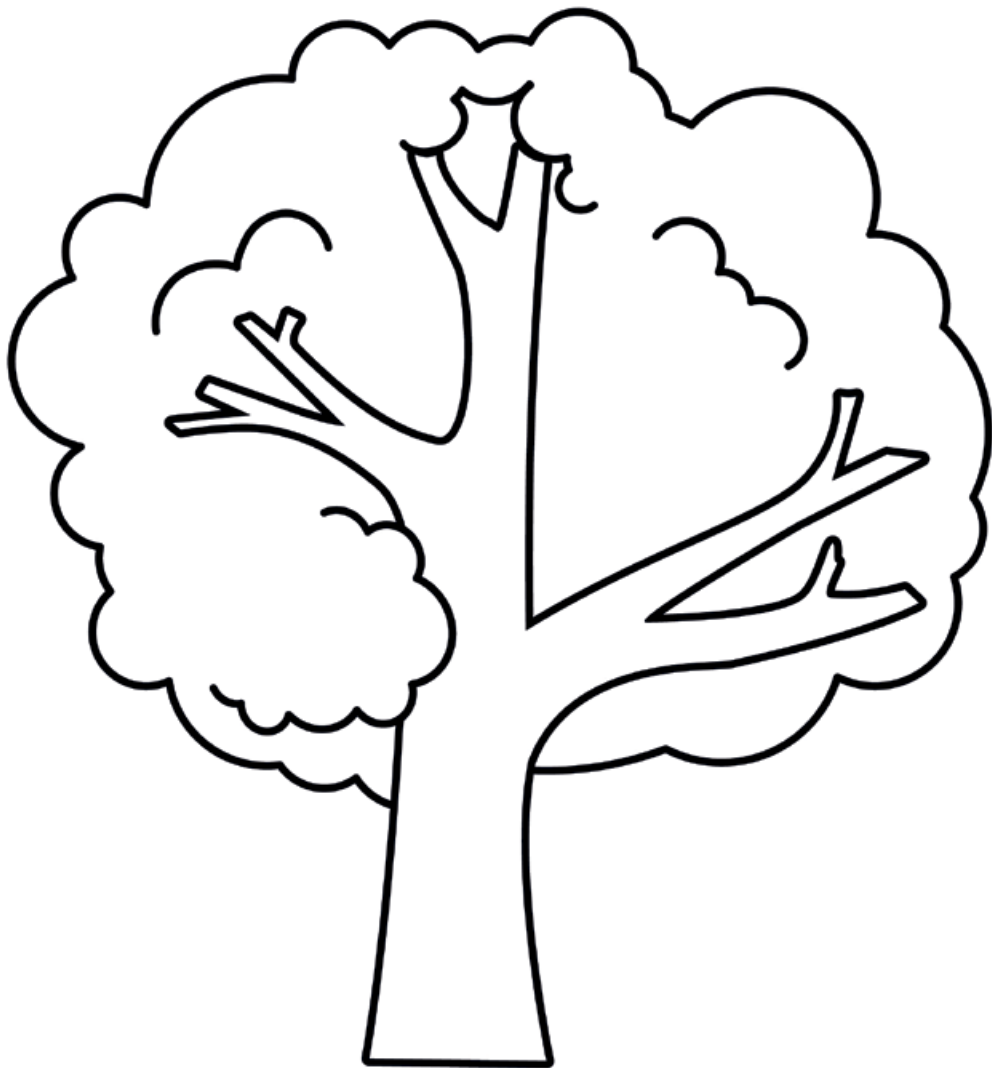

Boom

Oefen om te skryf

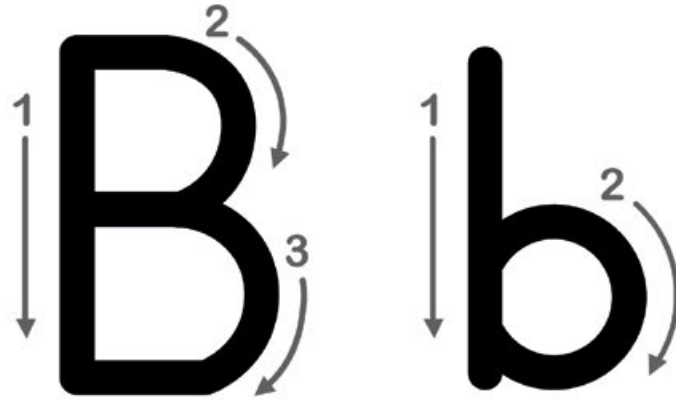

B B B

b b b

Boom

Voltooi die raaisel

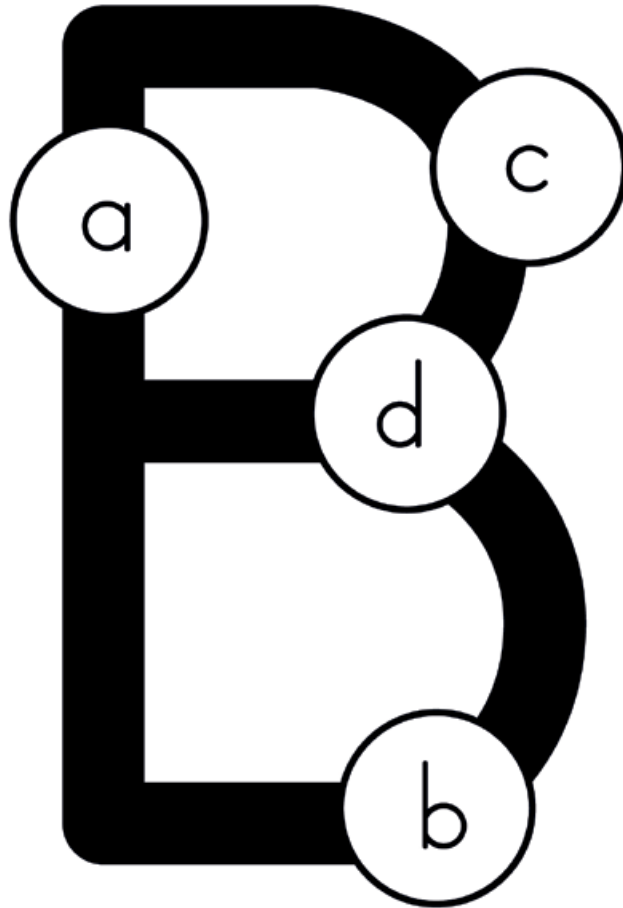

Cc



Cd

Oefen om te skryf

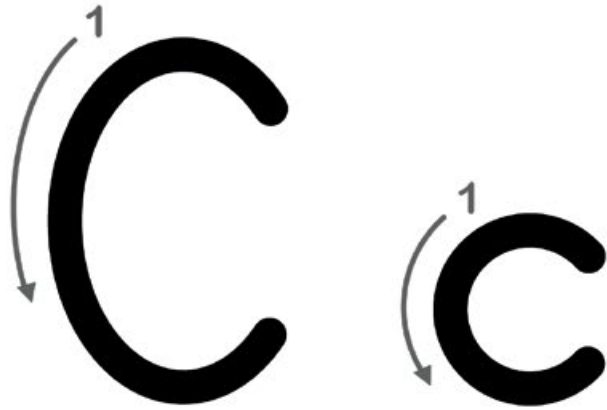

Watter skaduwee?

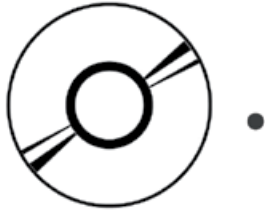

Dd

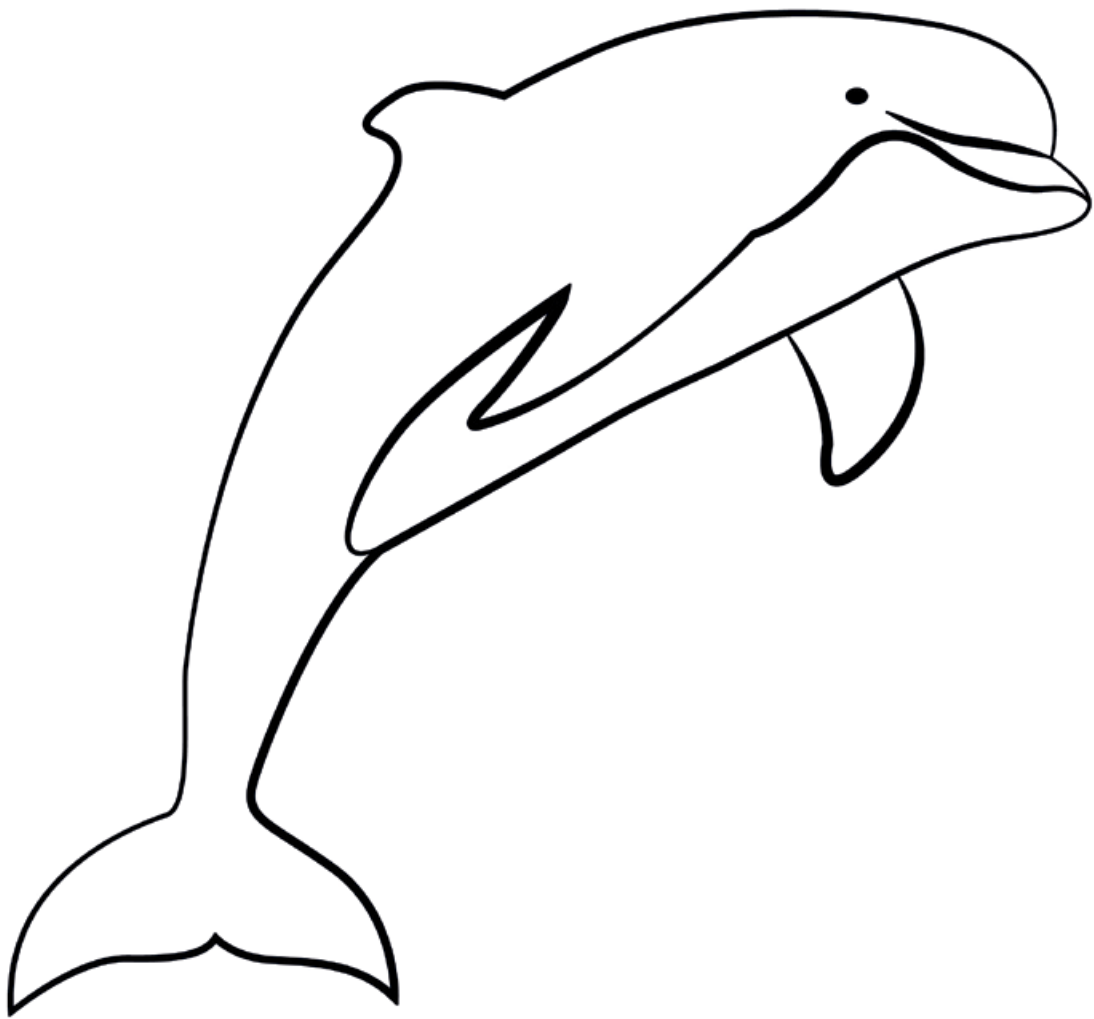

Dolfyn

Oefen om te skryf

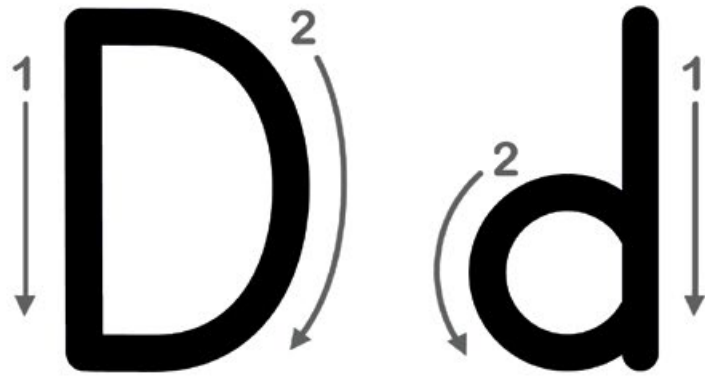

D D D

d d d

Dolfyn

Doolhofpret

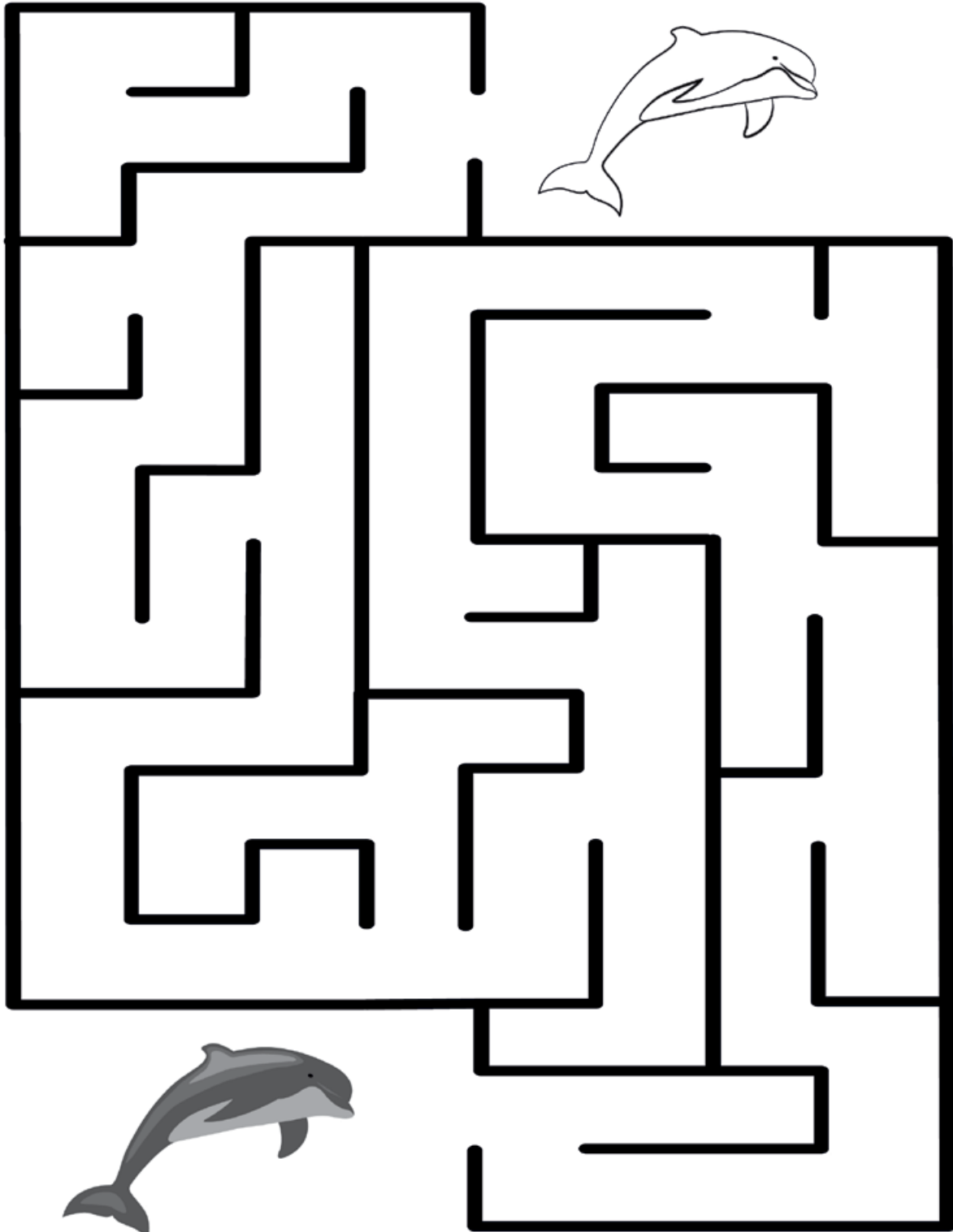

Ee

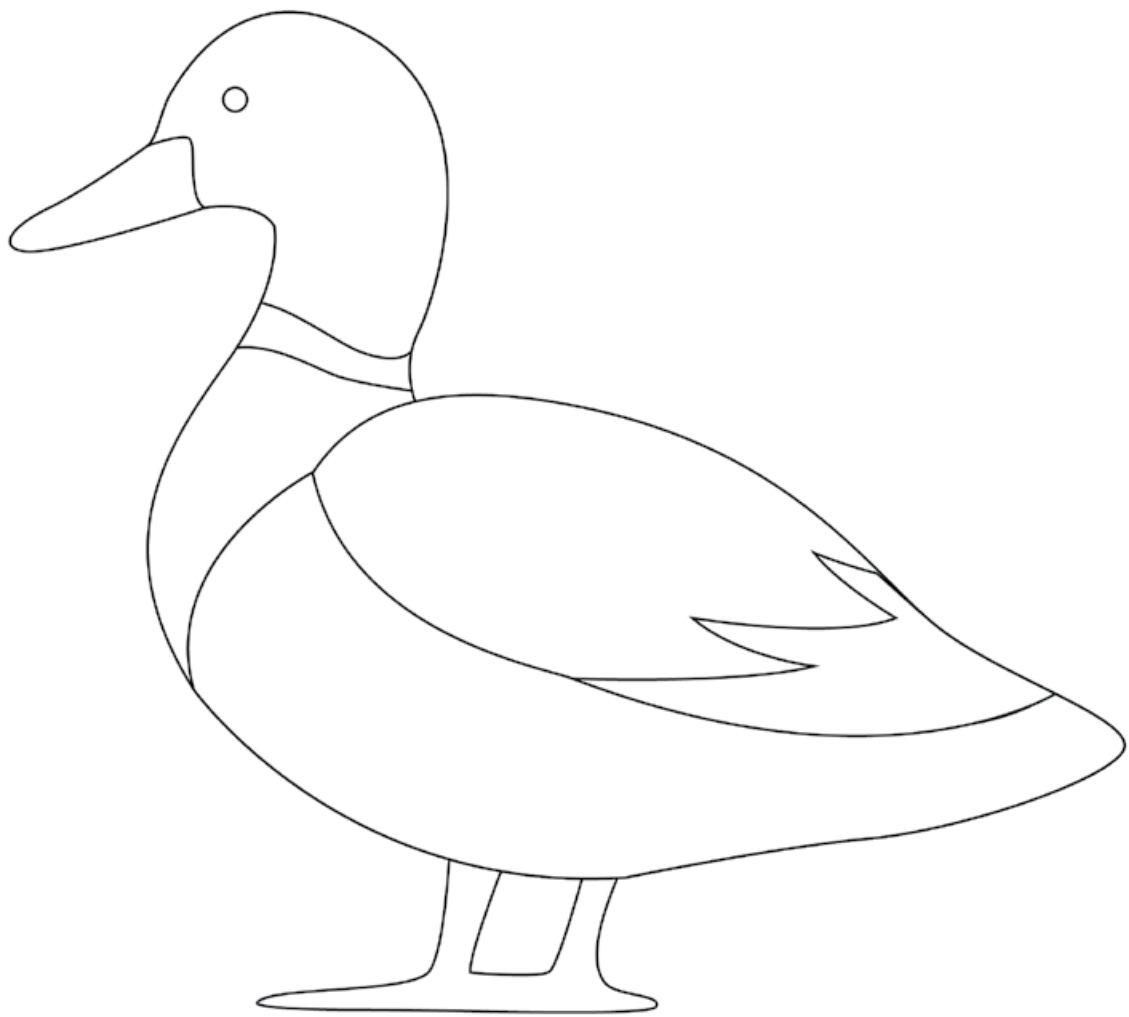

Eend

Oefen om te skryf

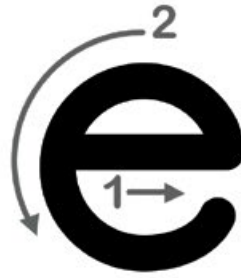
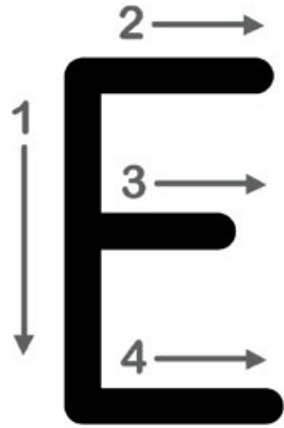

**Vind al die E's en e's
en kleur hulle in!**

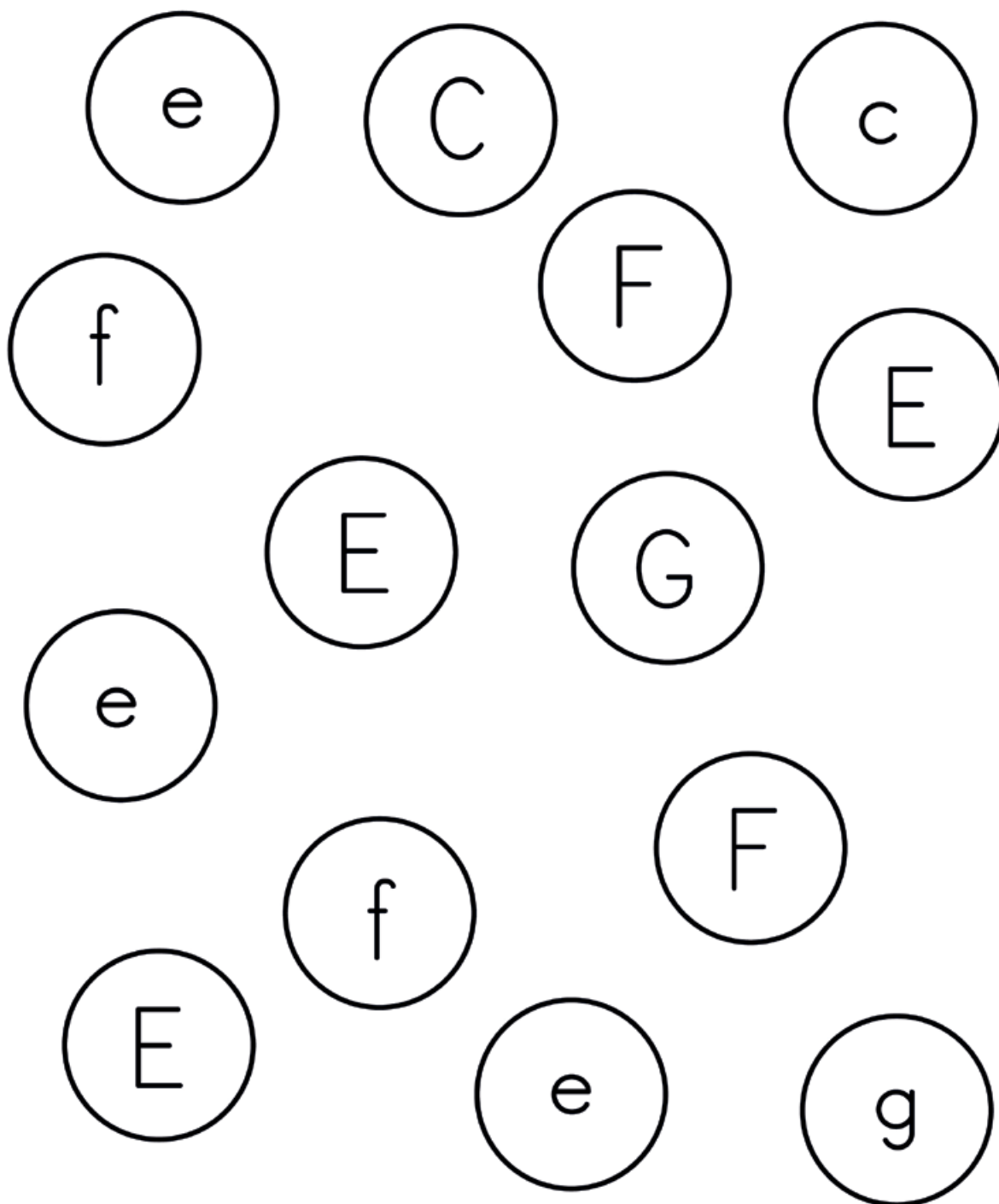

Ff

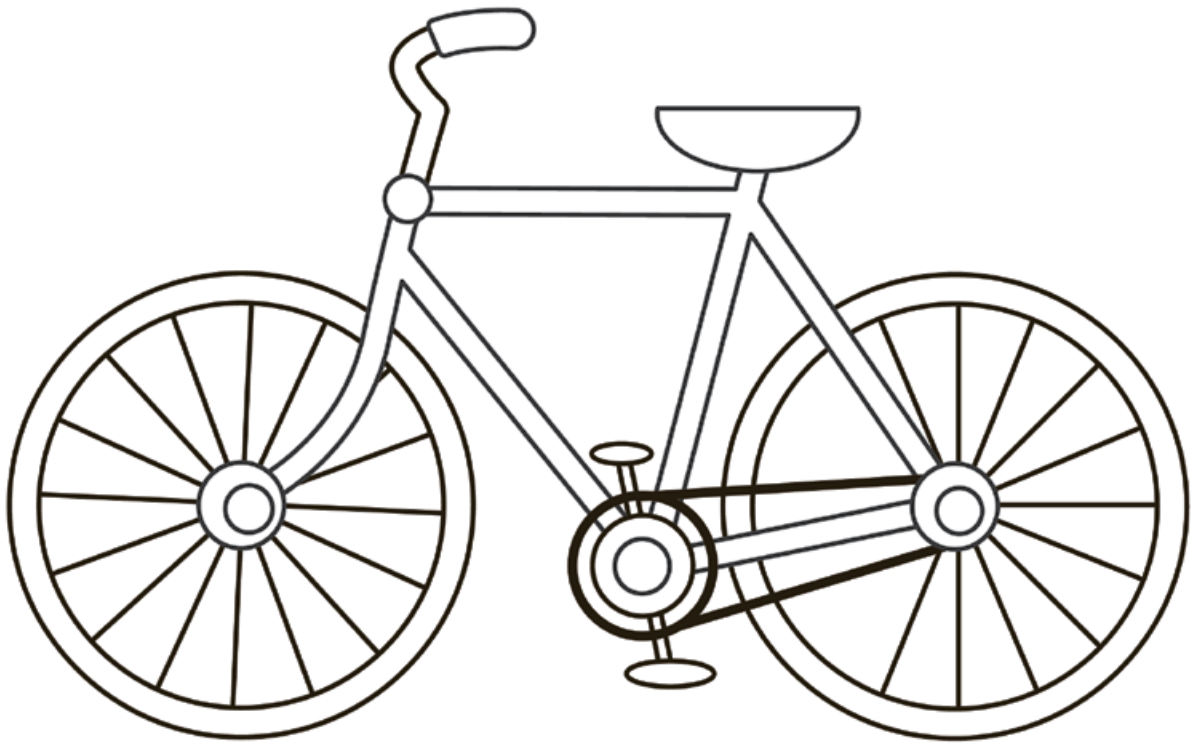

Fiets

Oefen om te skryf

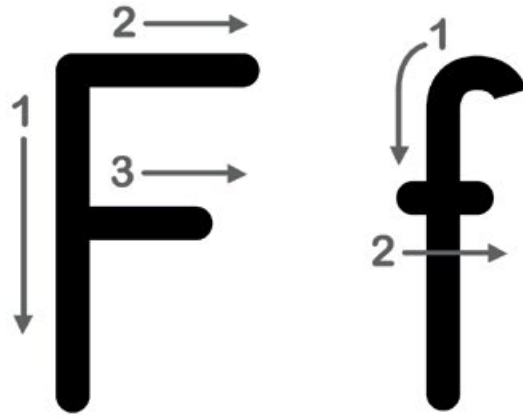

F F F

f f f

Fiets

Kol tot kol

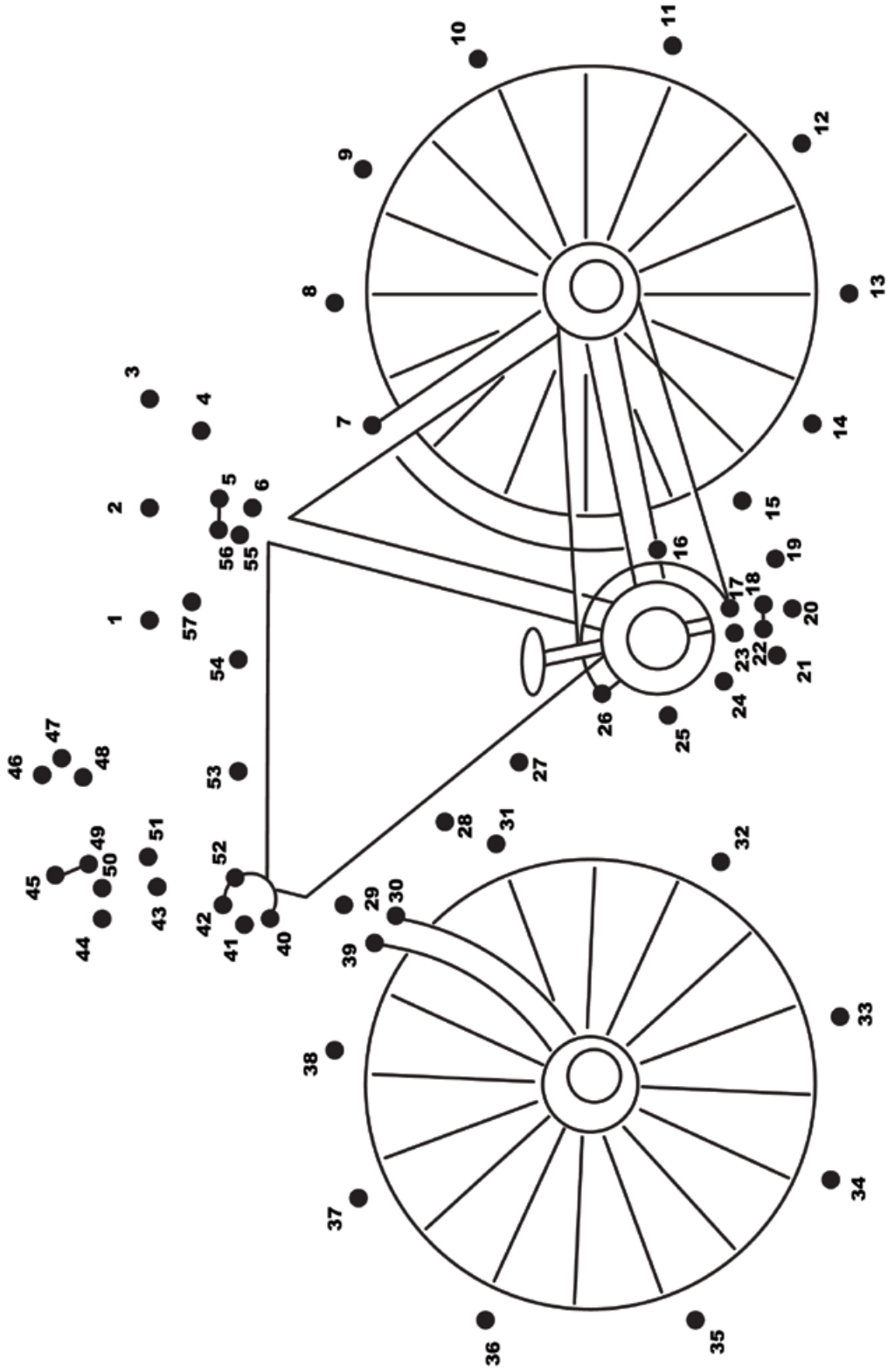

Gg

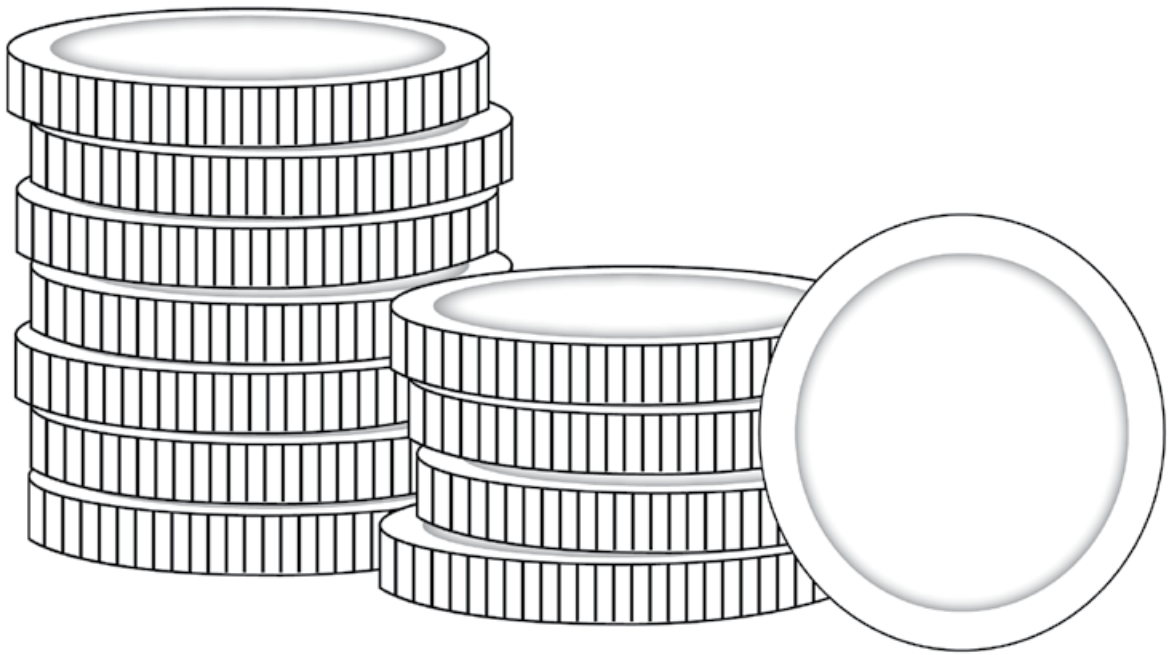

Geld

Oefen om te skryf

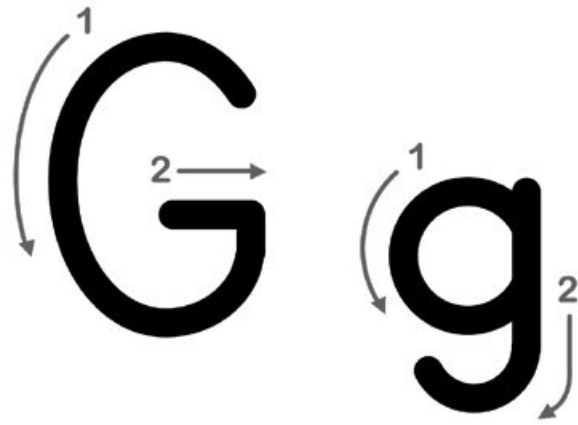

G G G

g g g

Geld

Pas bymekaar

2 .

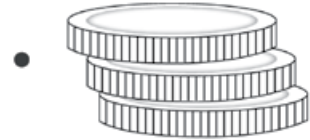

3 .



4 .

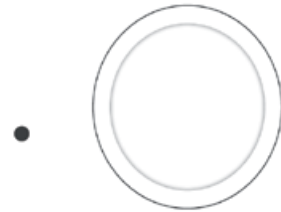

1 .



5 .



Hh

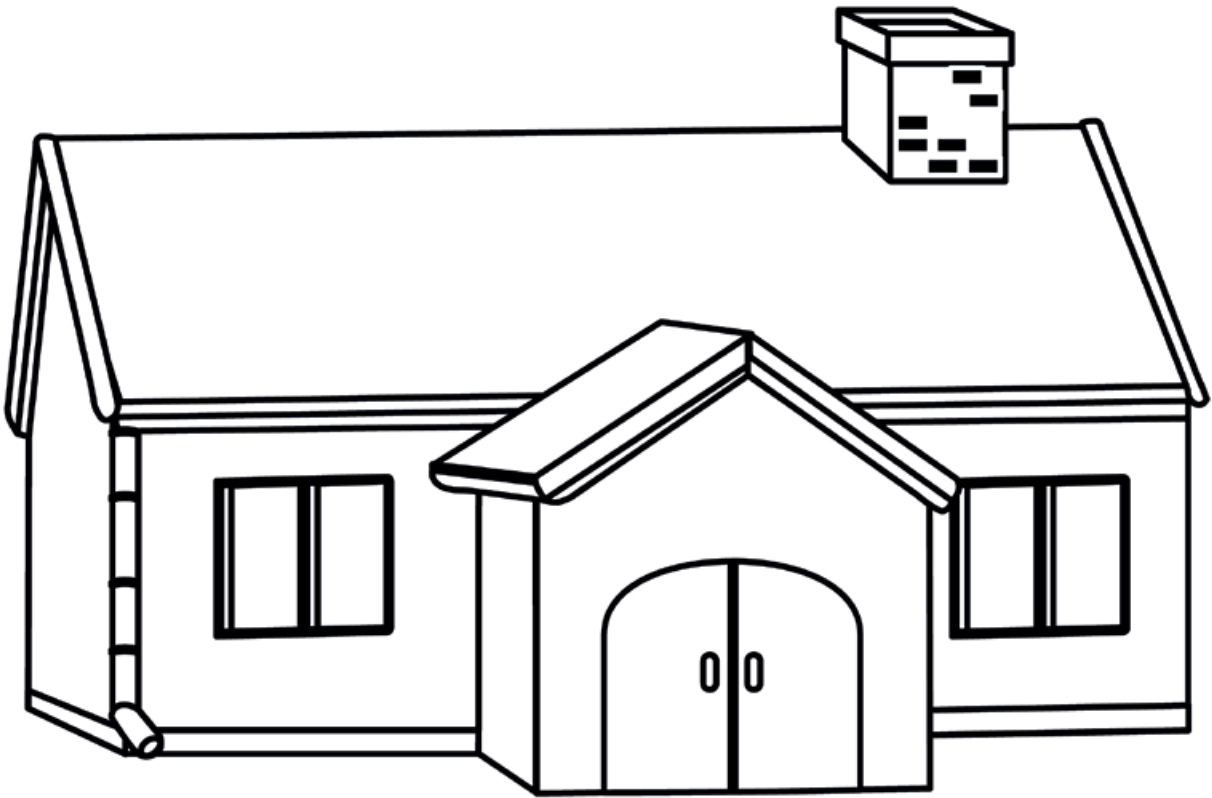

Huis

Oefen om te skryf

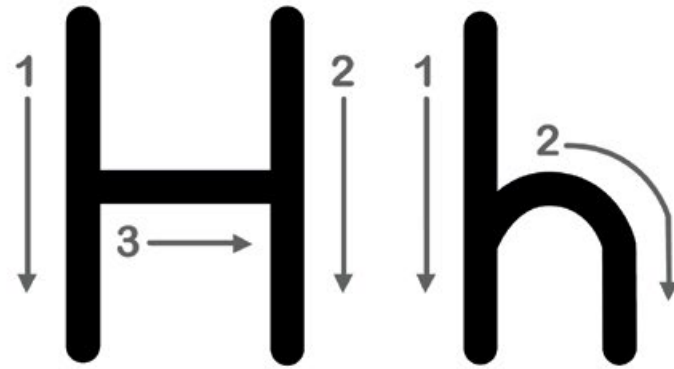

H H H

h h h

Huis

Voltooi die raaisel

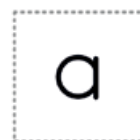
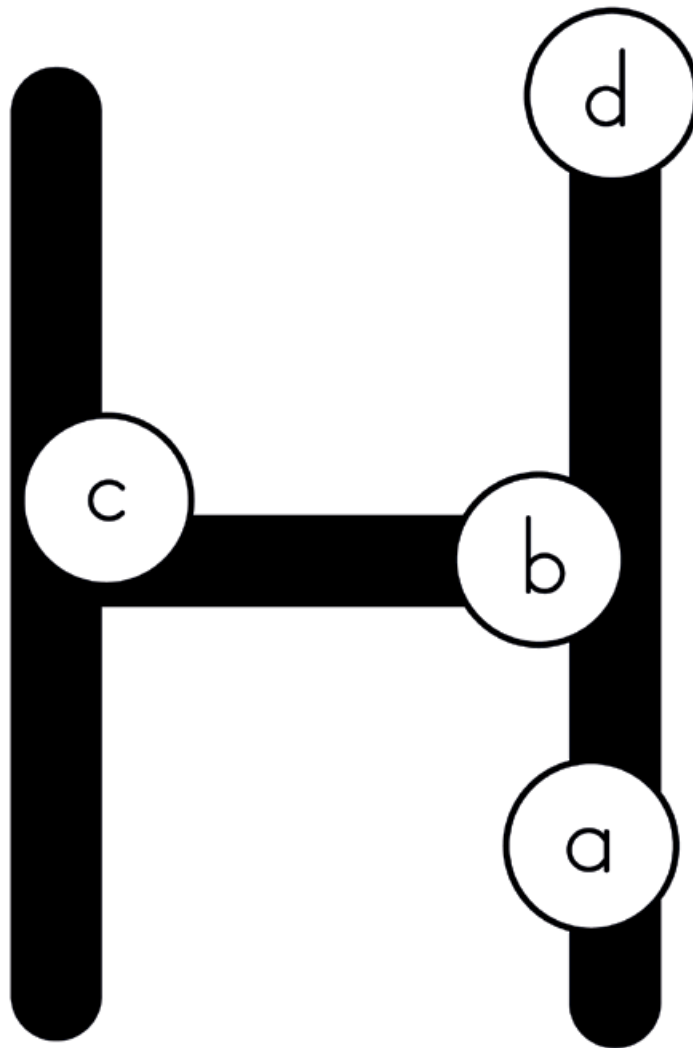

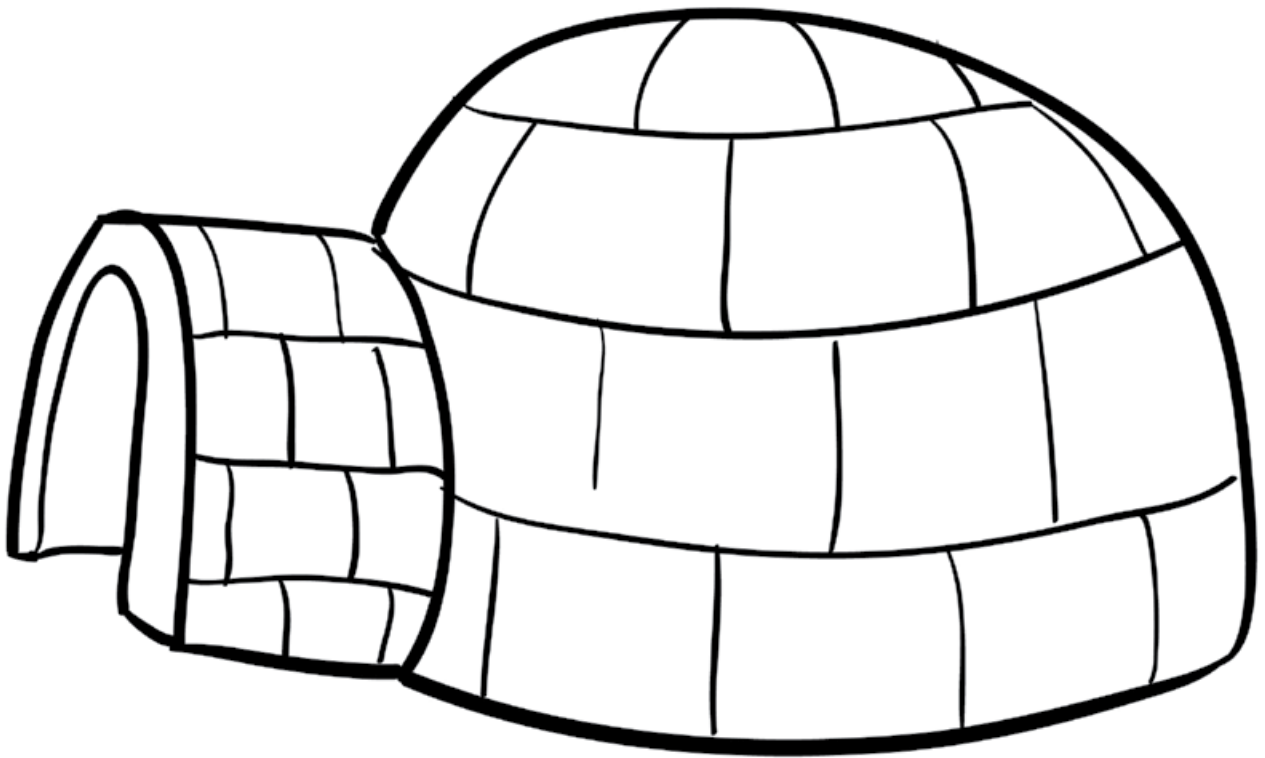
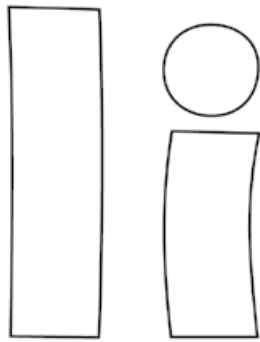

Igloe

Oefen om te skryf

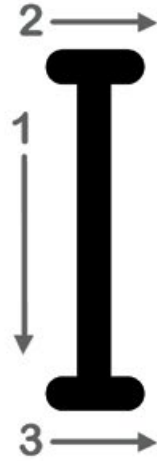

Pas bymekaar

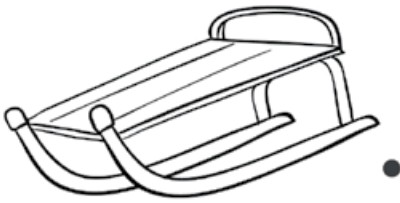

Jj



Jas

Oefen om te skryf

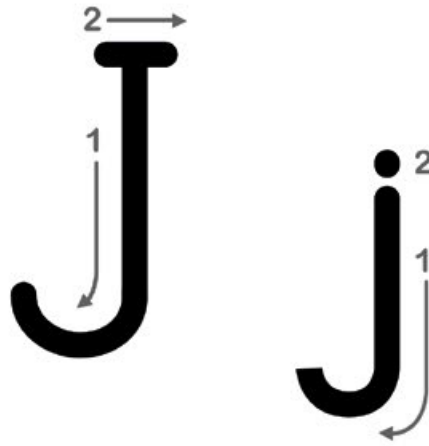

J J J

j j j

Jas

Vind al die J's en j's en kleur hulle in!

d

g

J

j

I

G

j

J

f

j

t

i

J

F

Kk

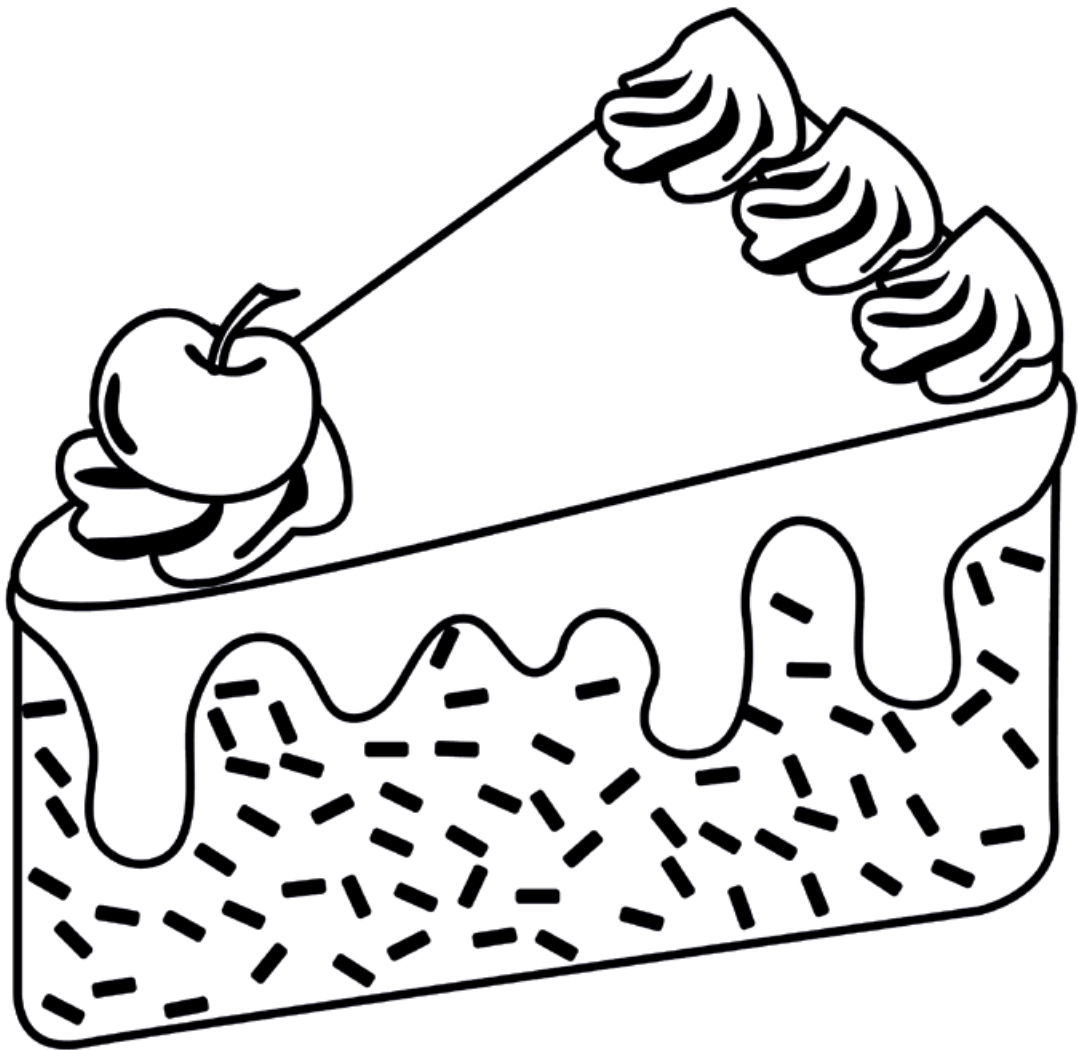

Koek

Oefen om te skryf

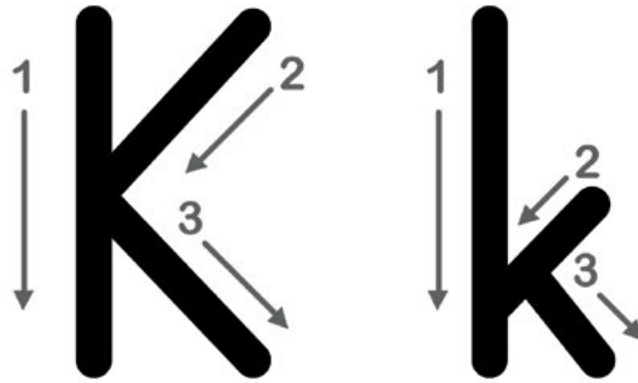

K K K

k k k

Koek

Watter skaduwee?



.

.



.

.



.

.



.

.



.

.



LI



Leeu

Oefen om te skryf

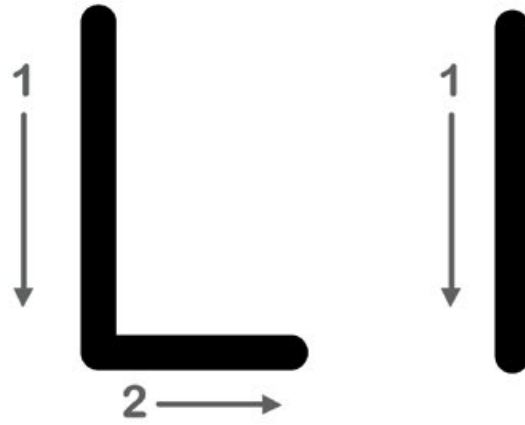

L L L

l l l

Leeu

Soek 5 verskille



M m

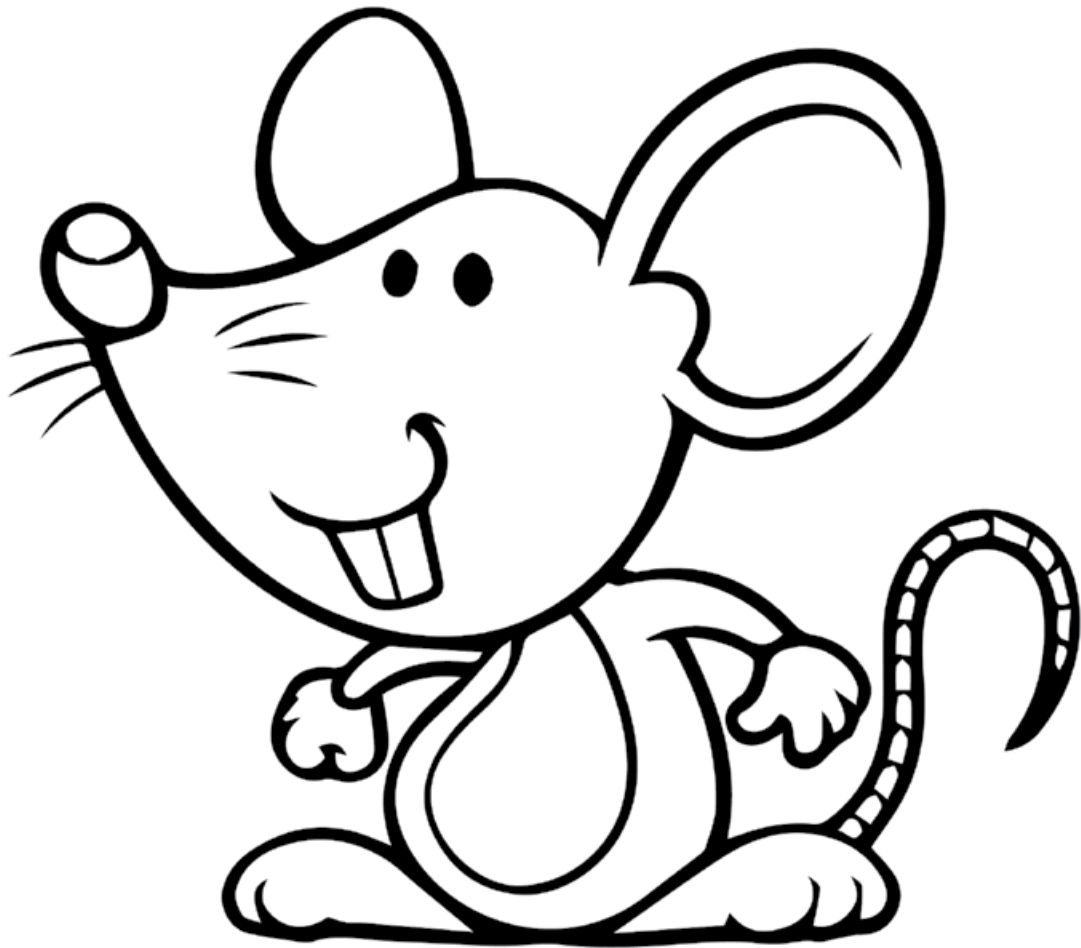

Muis

Oefen om te skryf

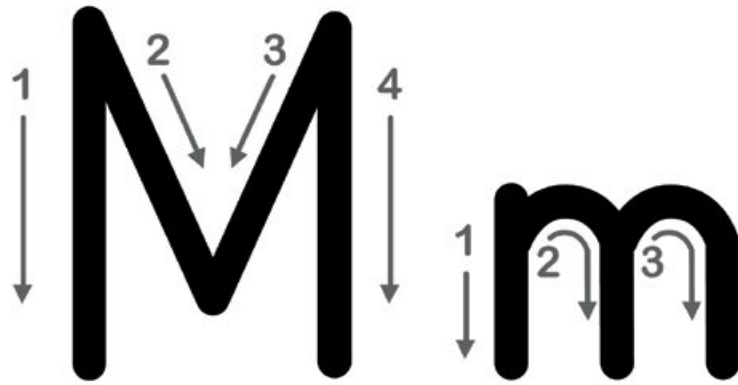

M M M

m m m

Muis

Kol tot kol



Nn

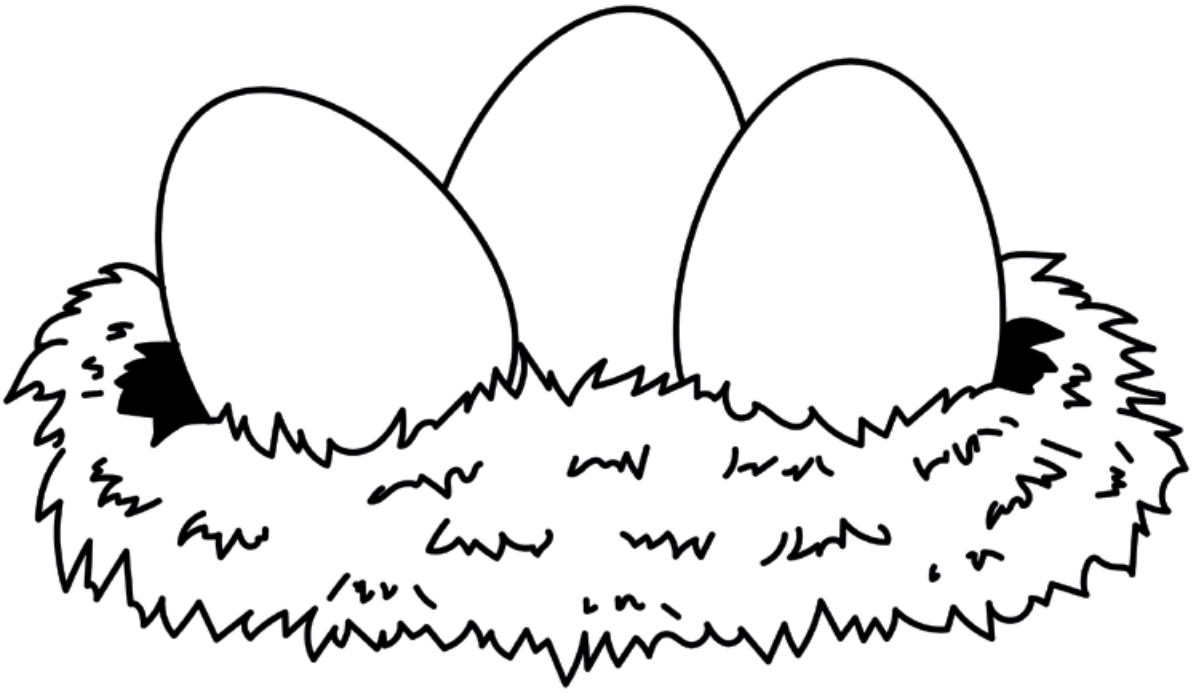

Nes

Oefen om te skryf

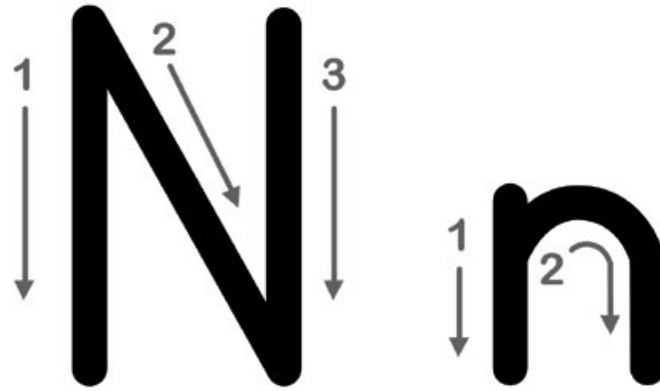

N N N

n n n

Nes

Voltooi die raaisel

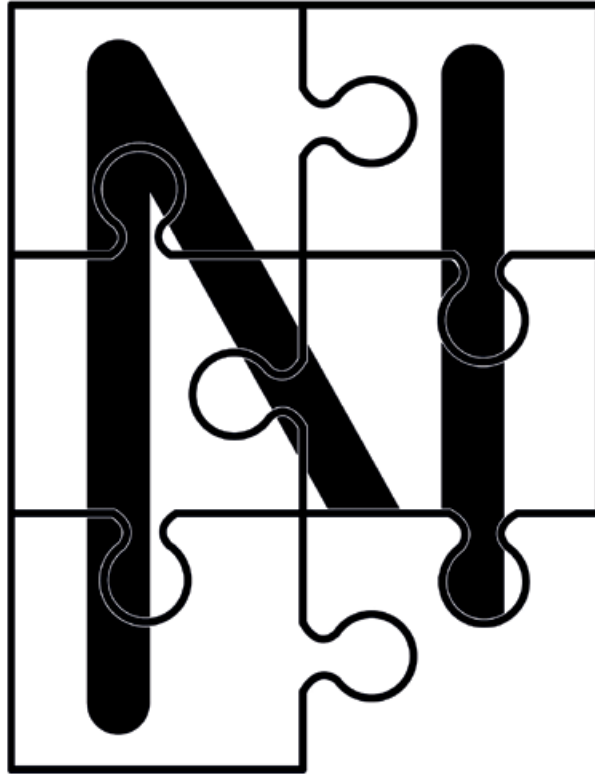

a

b

c

Antwoord: _____

O o

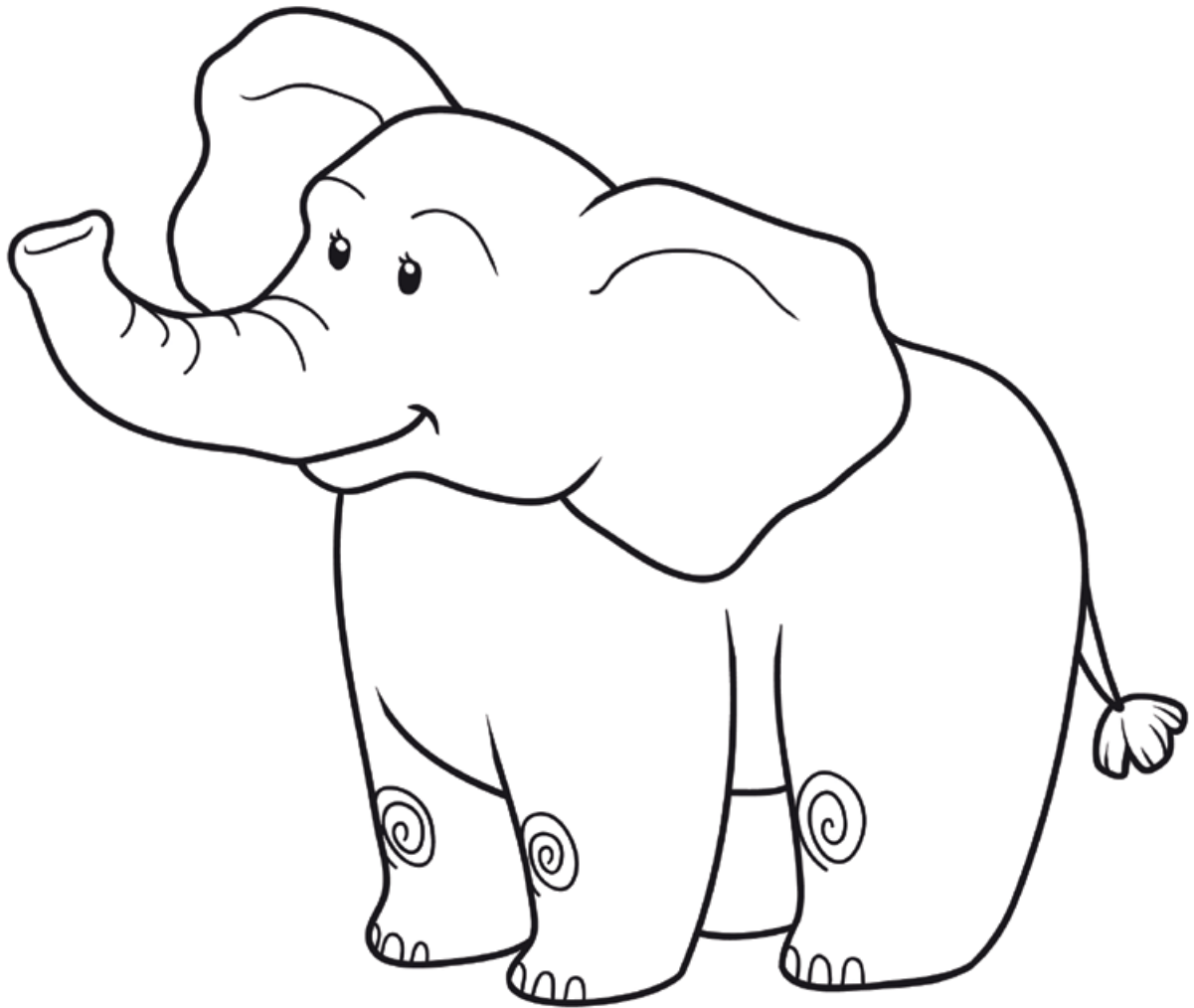

Olifant

Oefen om te skryf

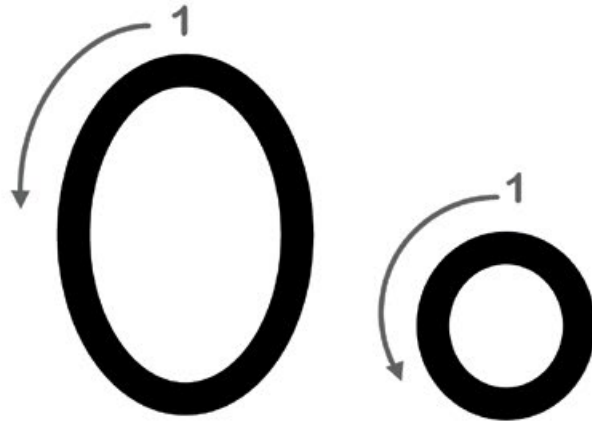

Olifant

Tel bymekaar

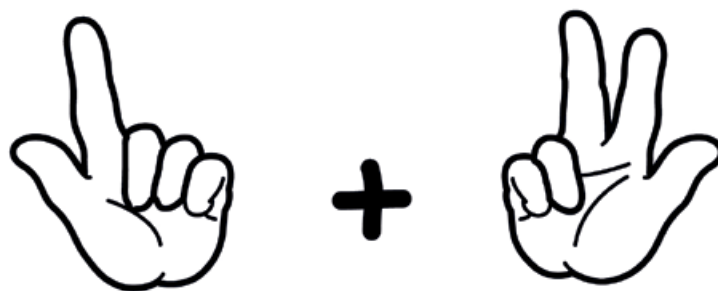
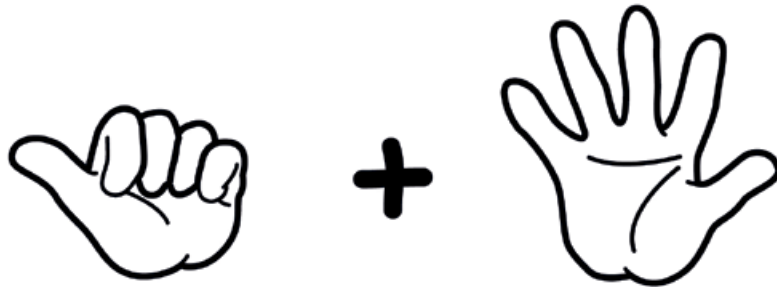

Pp

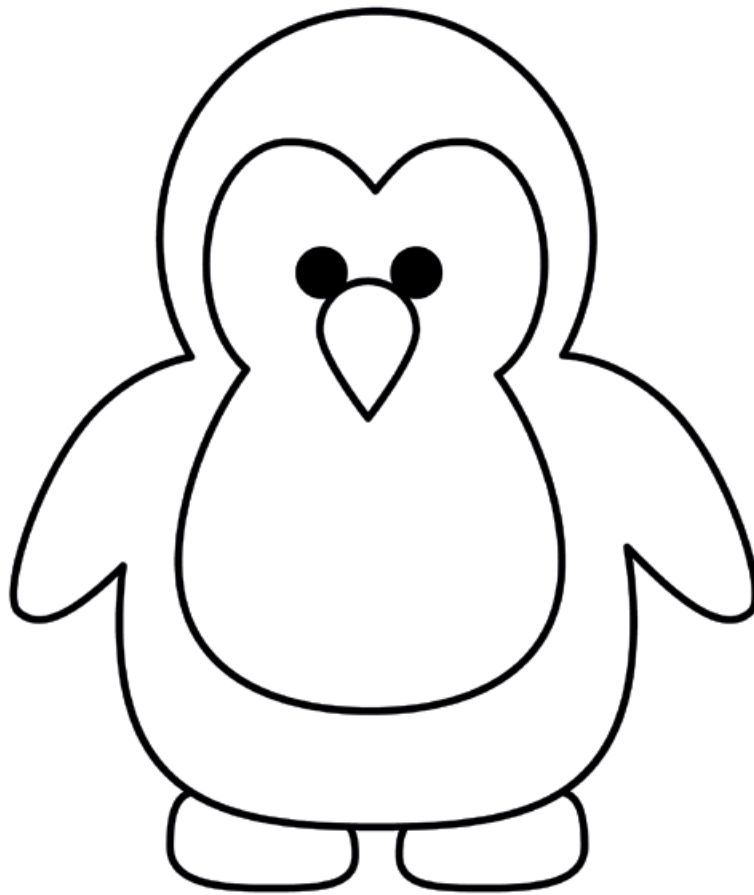

Pikkewyn

Oefen om te skryf

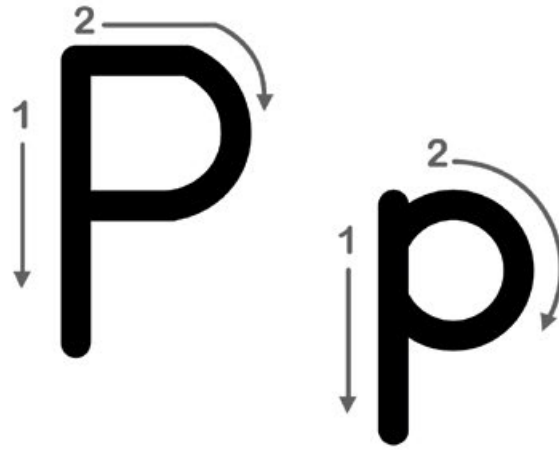

P P P

p p p

Pikkewyn

Tekenoefening

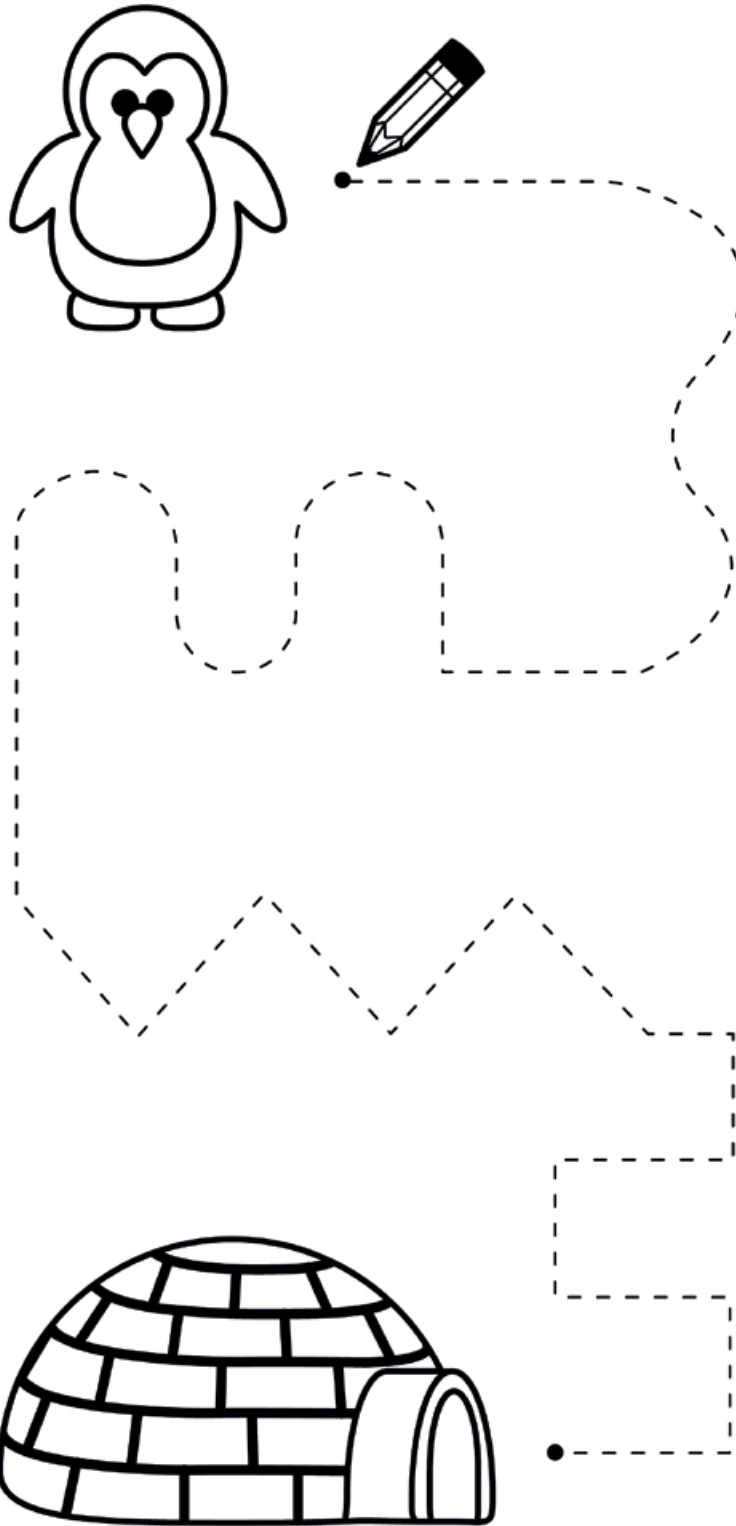

Q q



Quiche

Oefen om te skryf

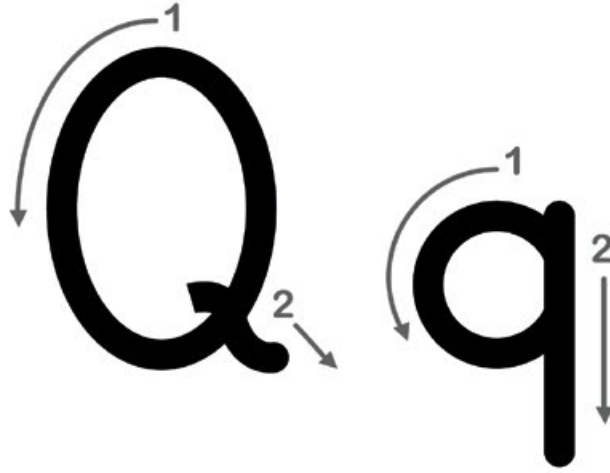

Tel bymekaar

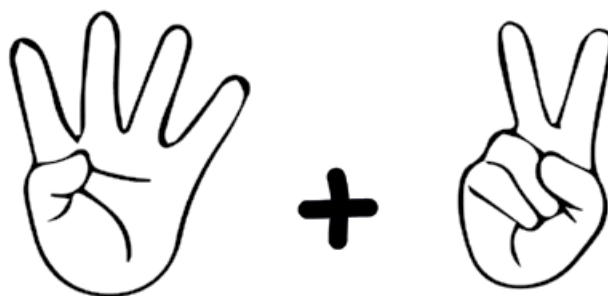
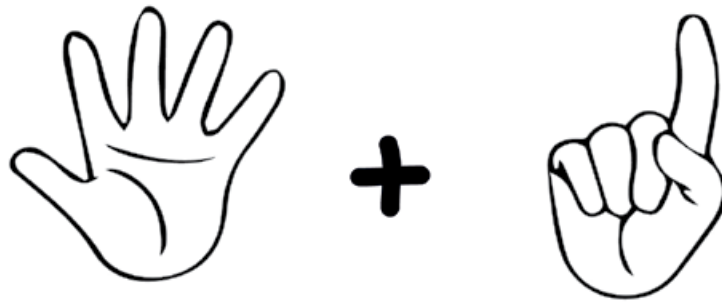

Rr

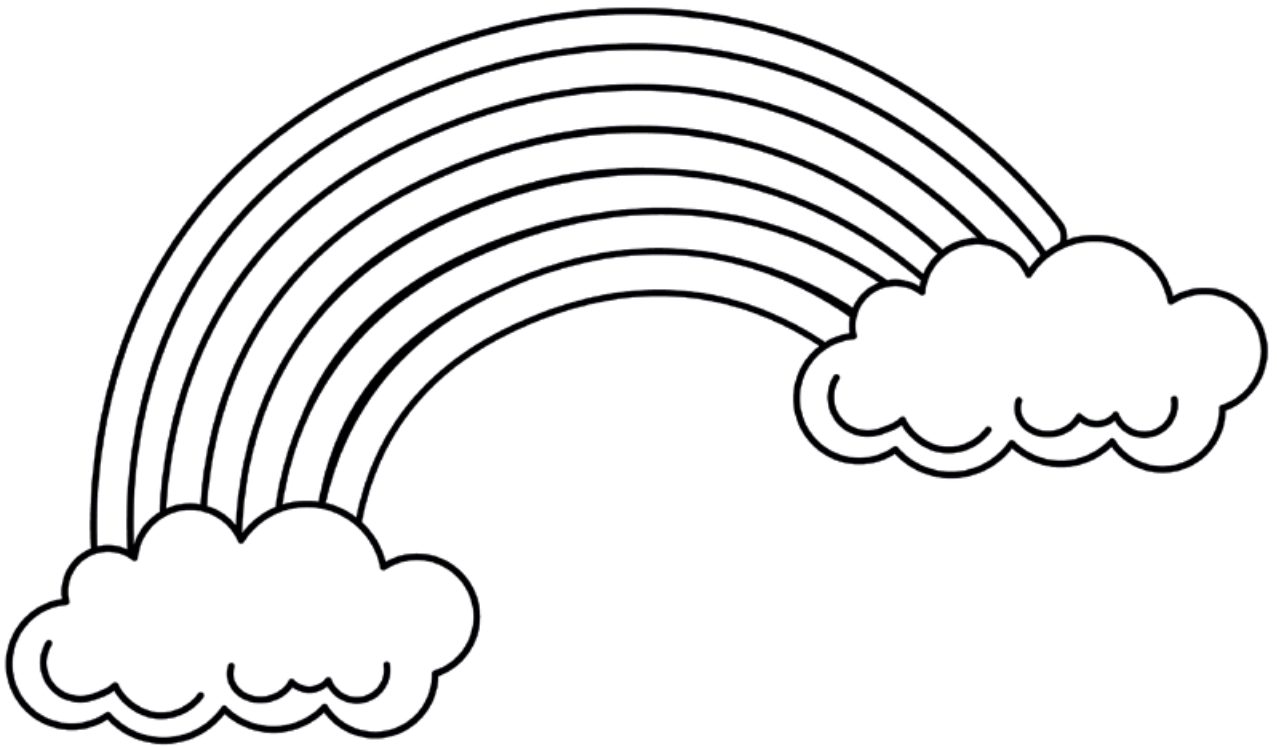

Reënboog

Oefen om te skryf

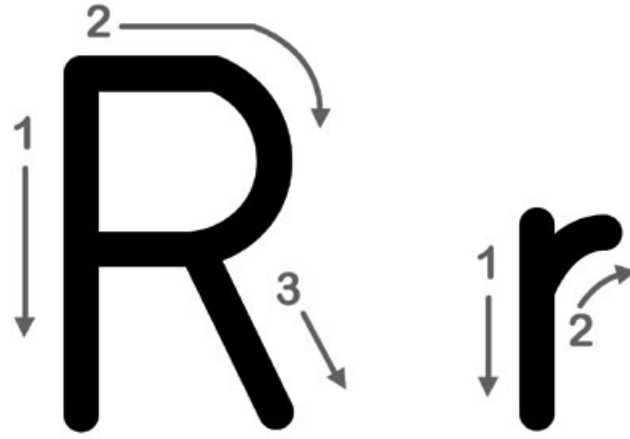

R R R

r r r

Reënboog

Kleure van die reënboog

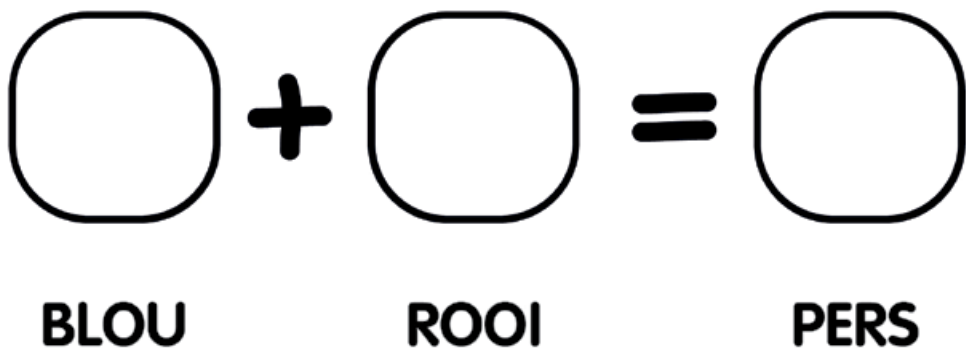
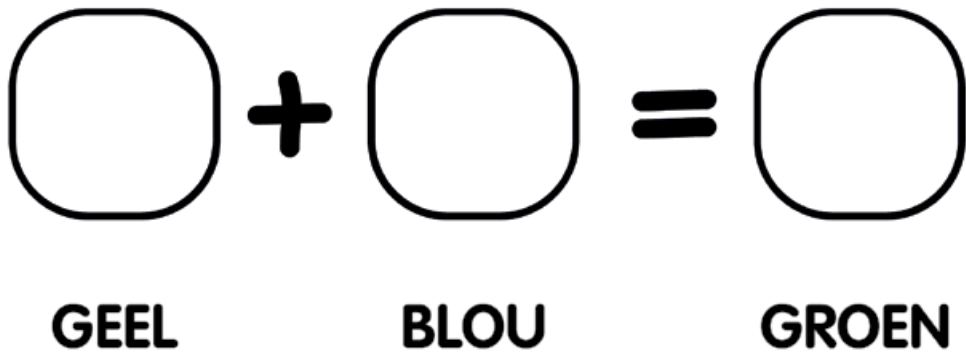
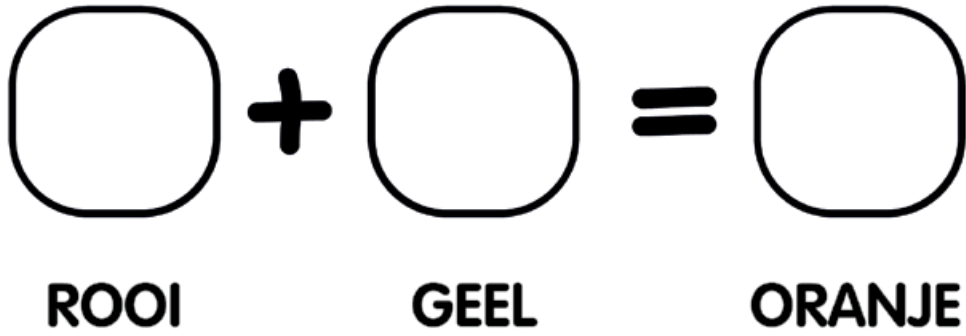

Ss

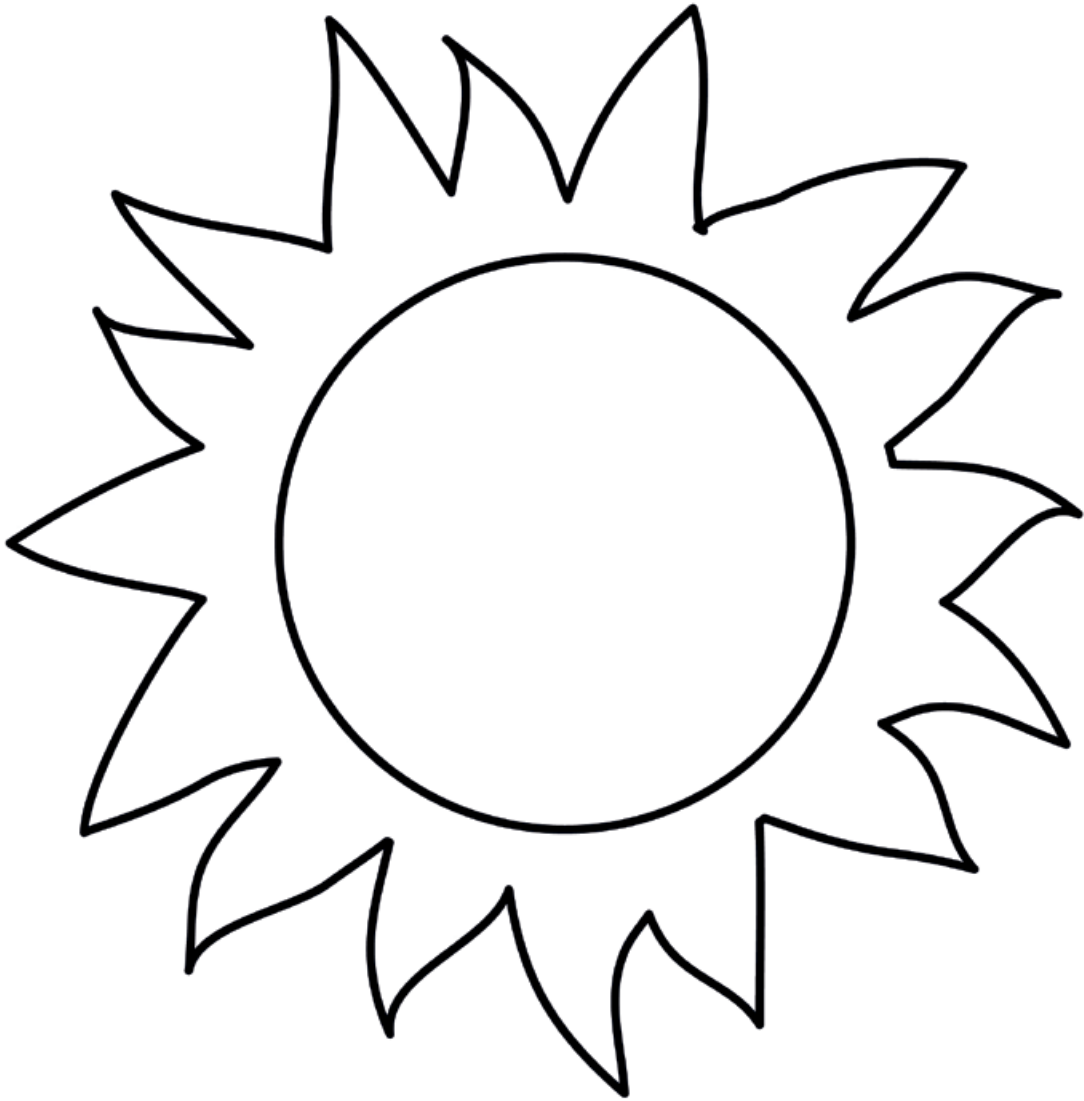

Son

Oefen om te skryf

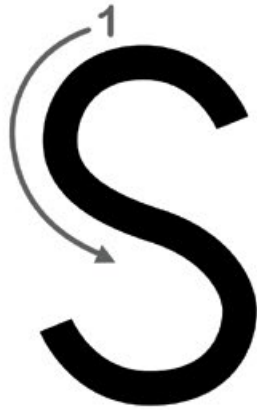

S S S

s s s

son

Hoeveel?

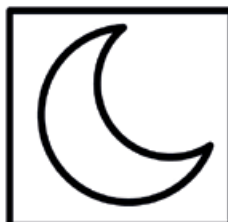
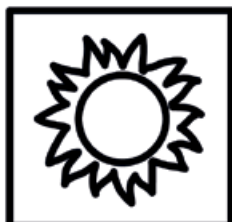

Tt



Teddiebear

Oefen om te skryf

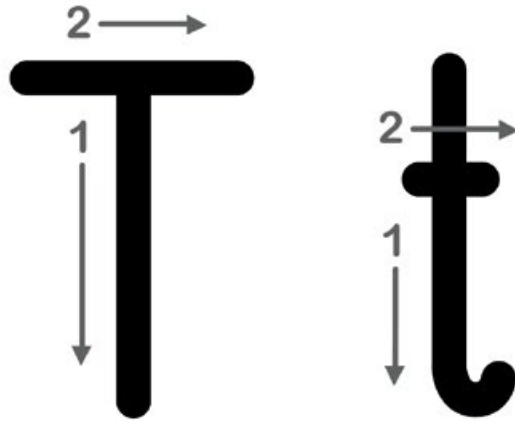

Soek 5 verskille

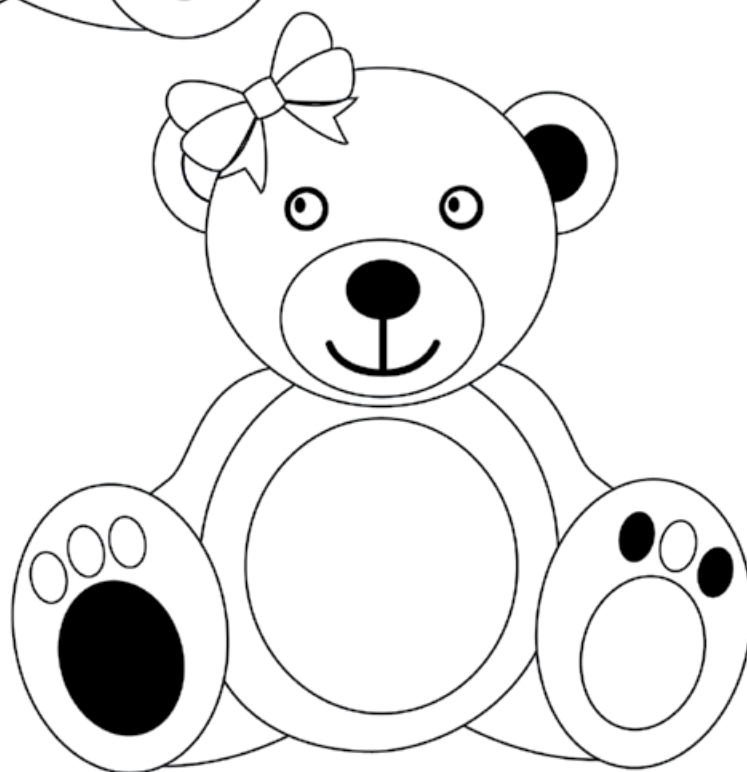
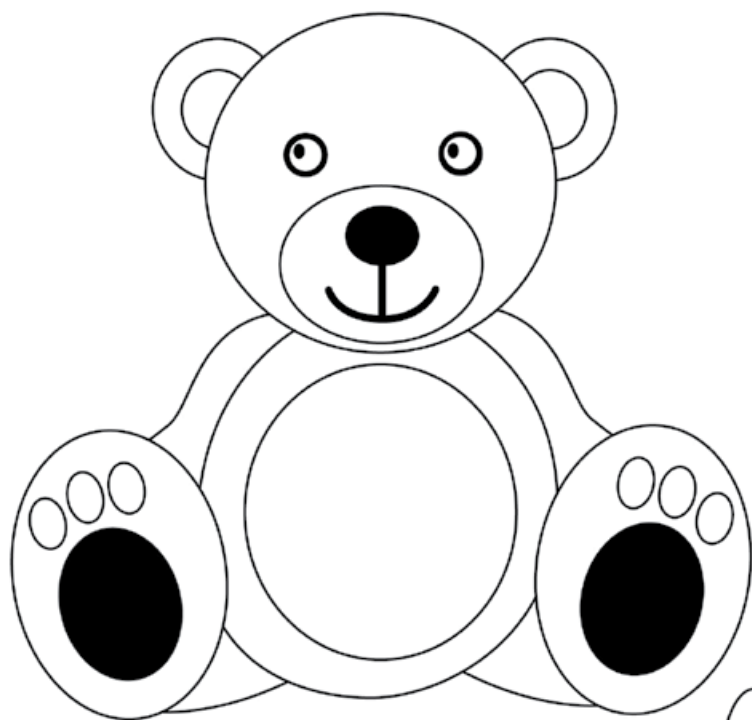

U u

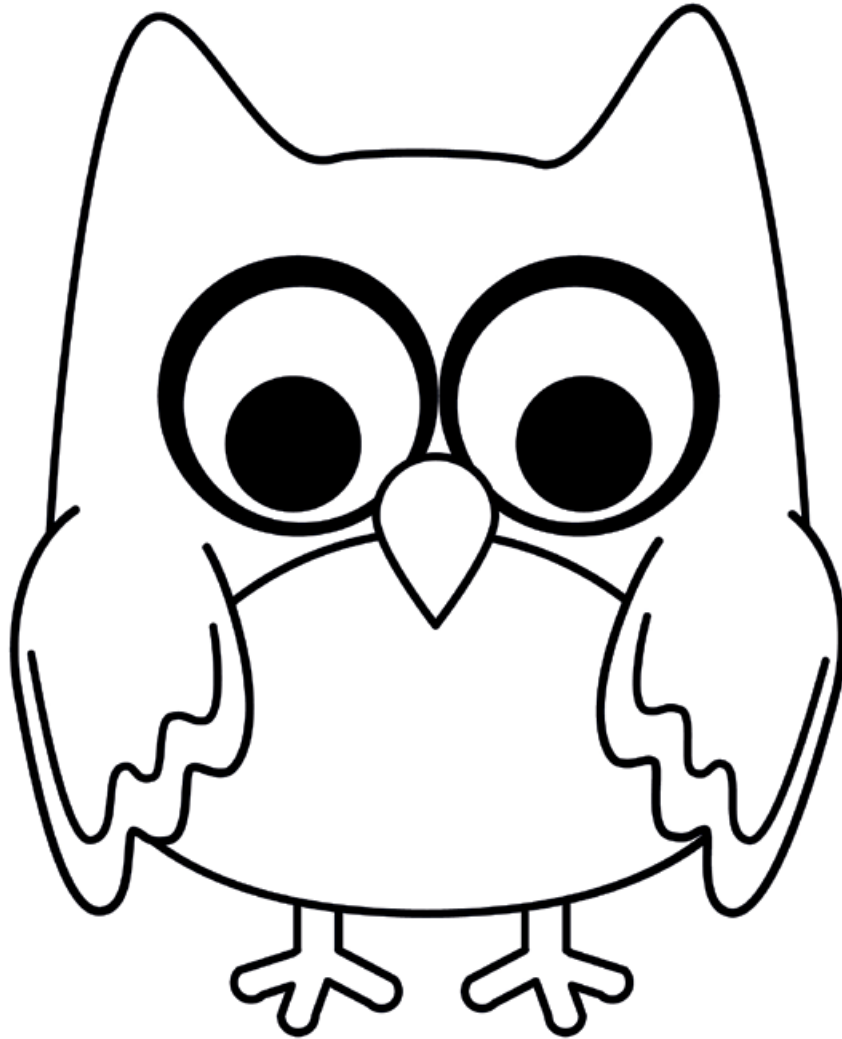

Uil

Oefen om te skryf

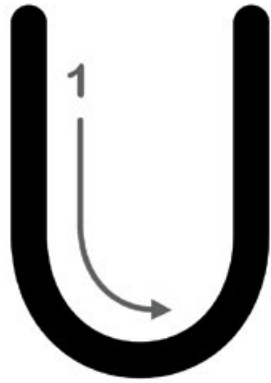

Tel bymekaar

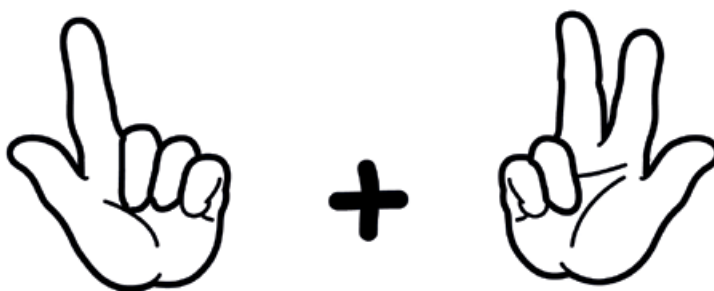
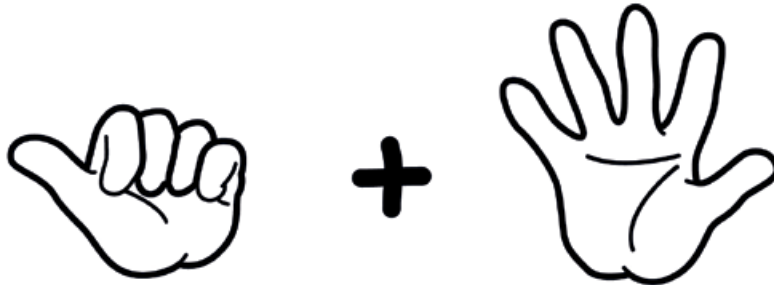

V v

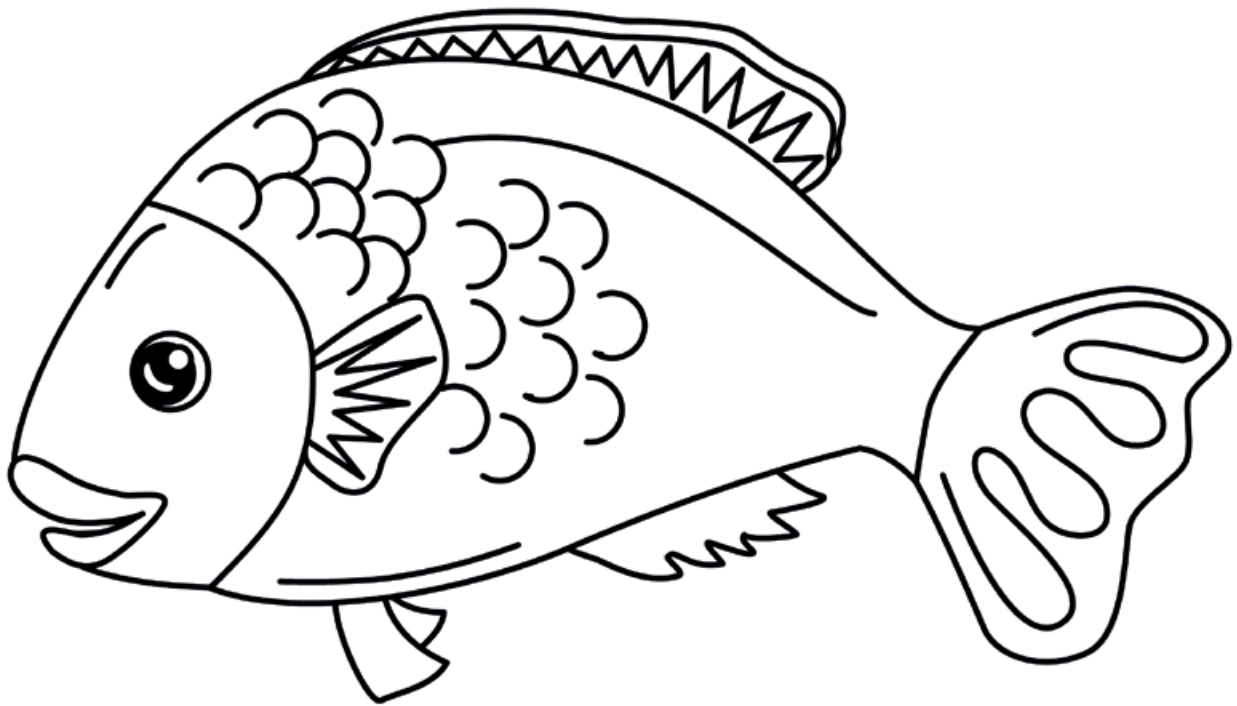

Vis

Oefen om te skryf

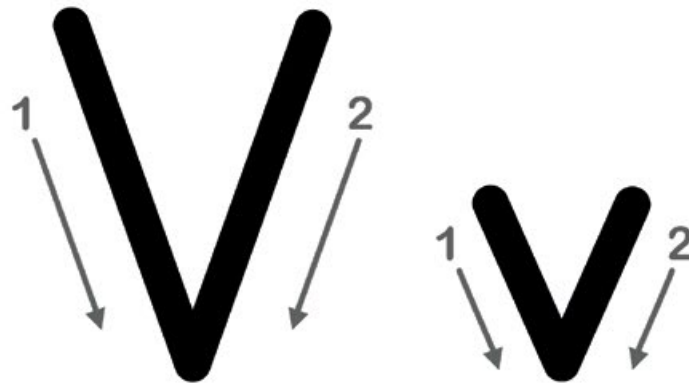

Doolhofpret



W w

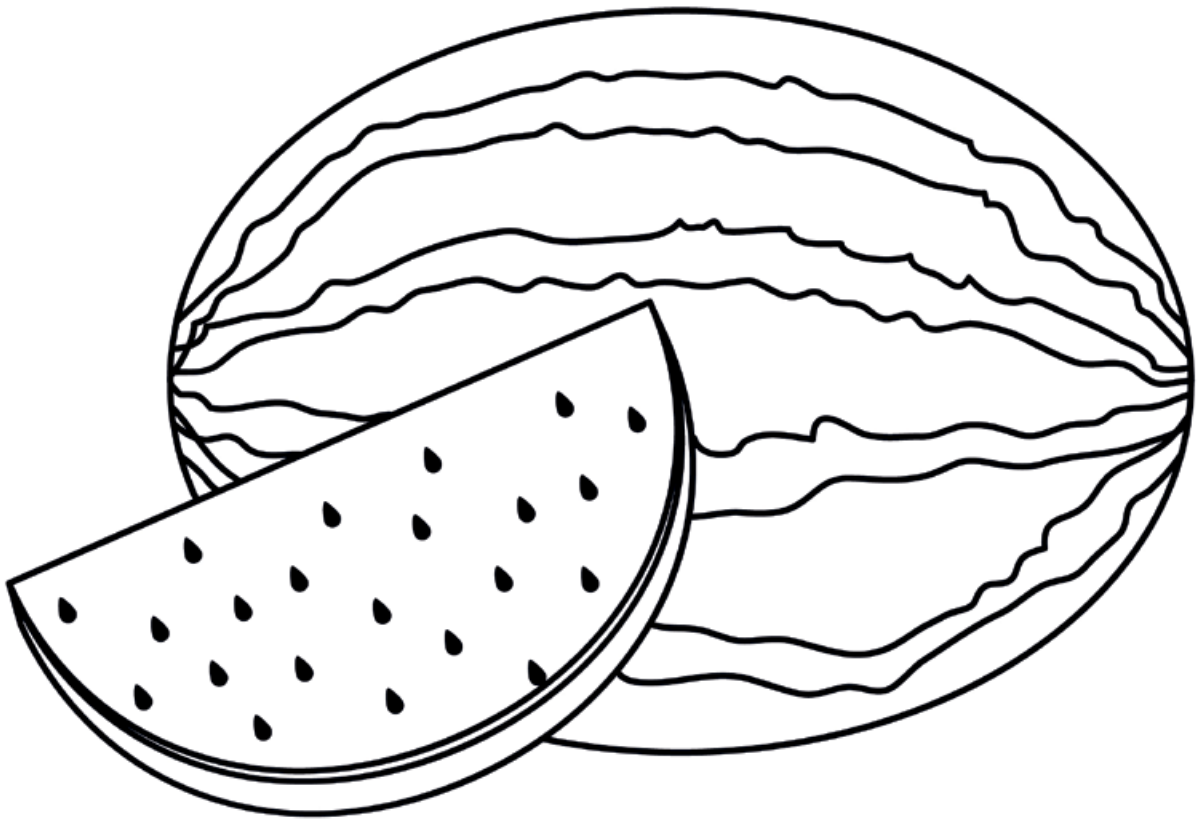

Waattlemoen

Oefen om te skryf

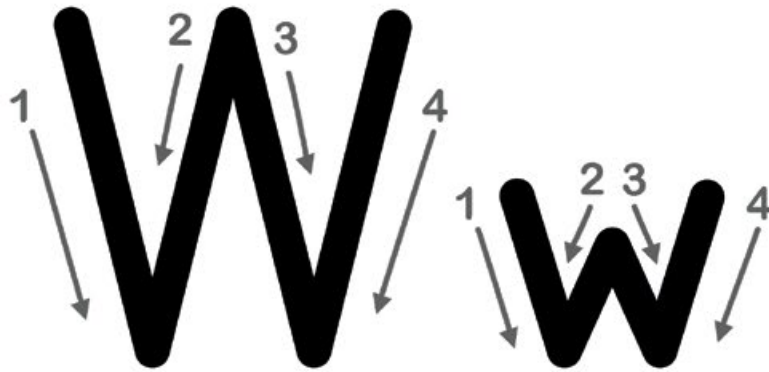

w w w

w w w

Waaiemoen

Pas bymekaar

4 .



8 .



5 .



6 .



7 .



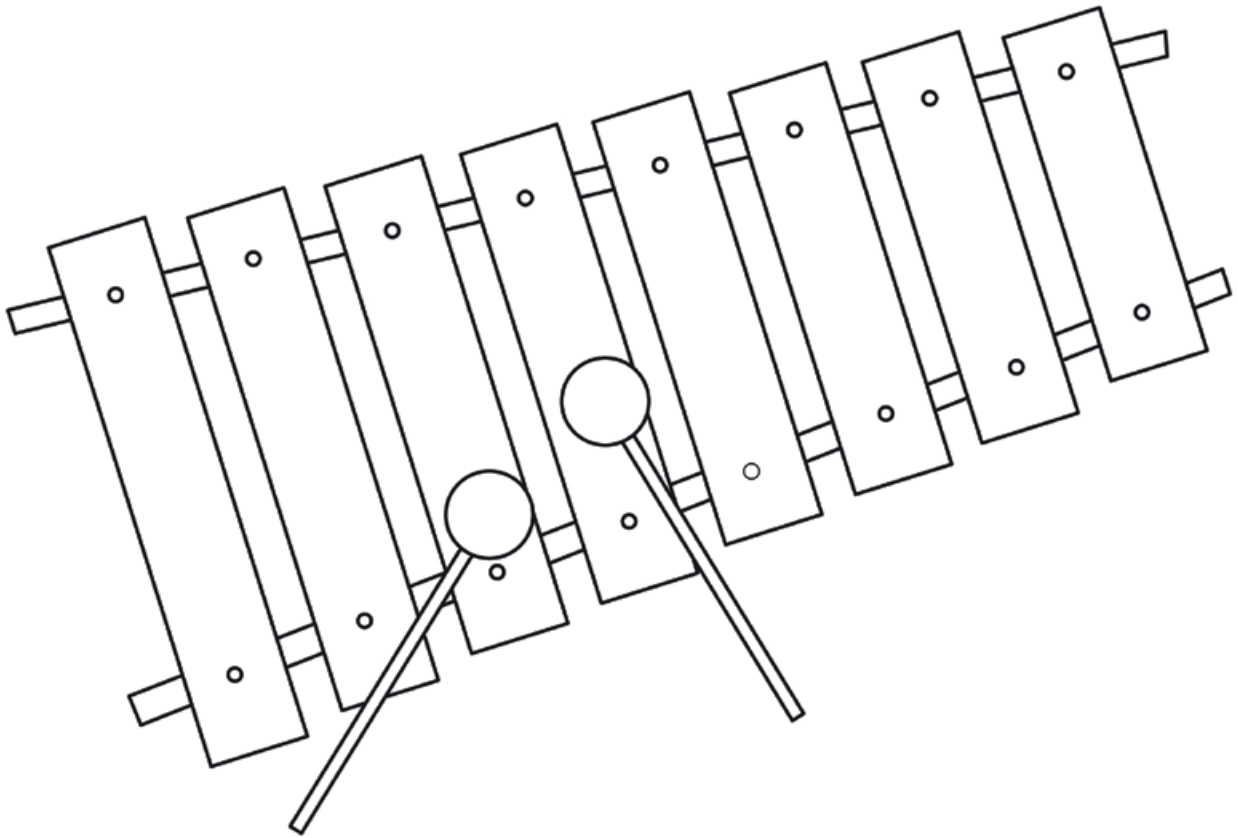

Xilofoon

Oefen om te skryf

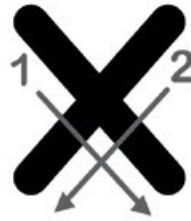
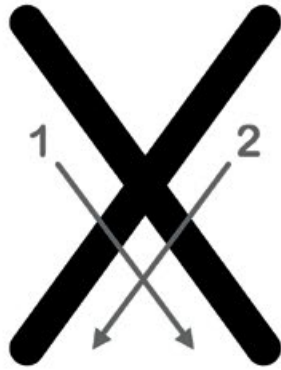

Xilofoon

**Vind al die X'e en x'e
en kleur hulle in.**

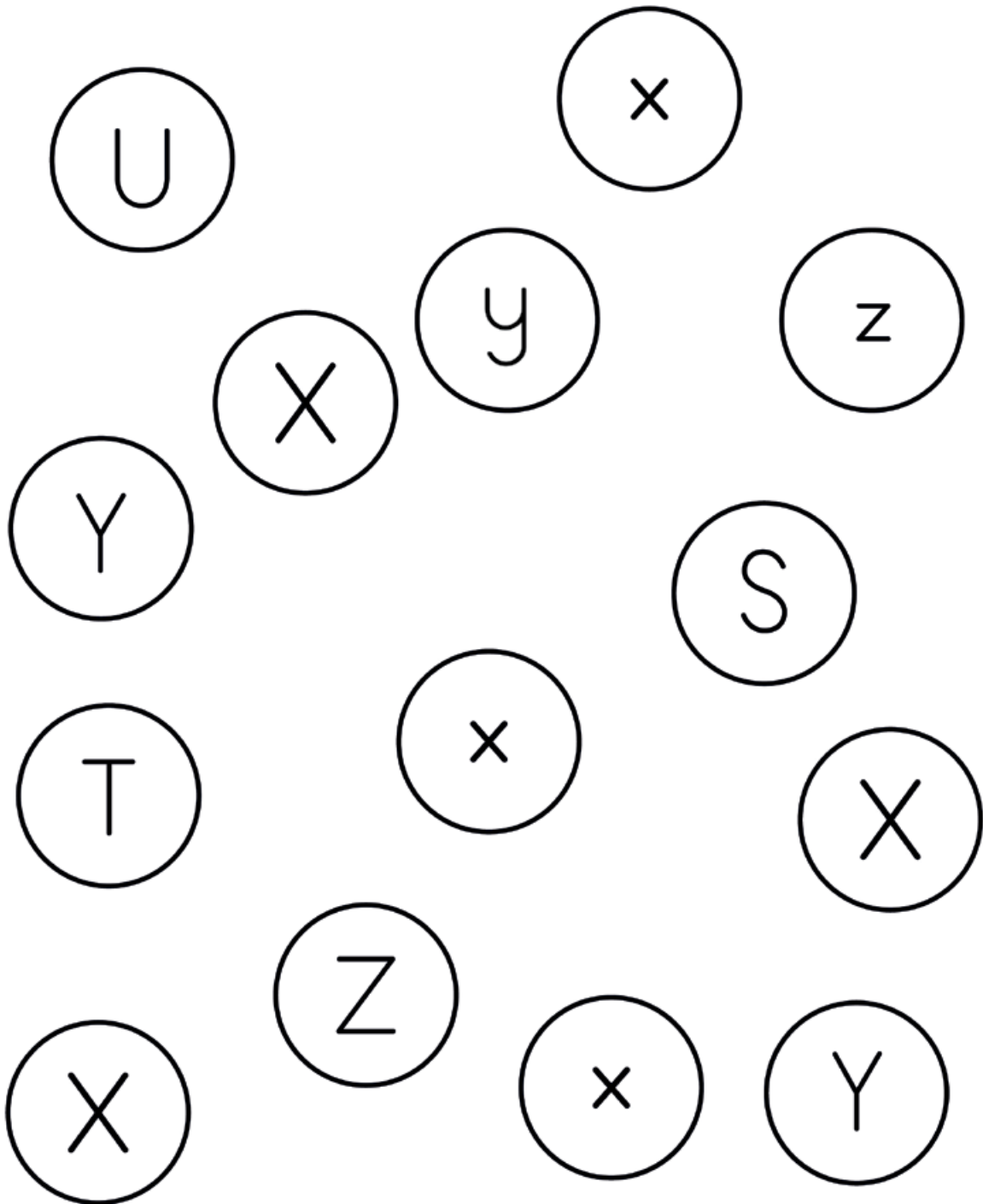

Yy

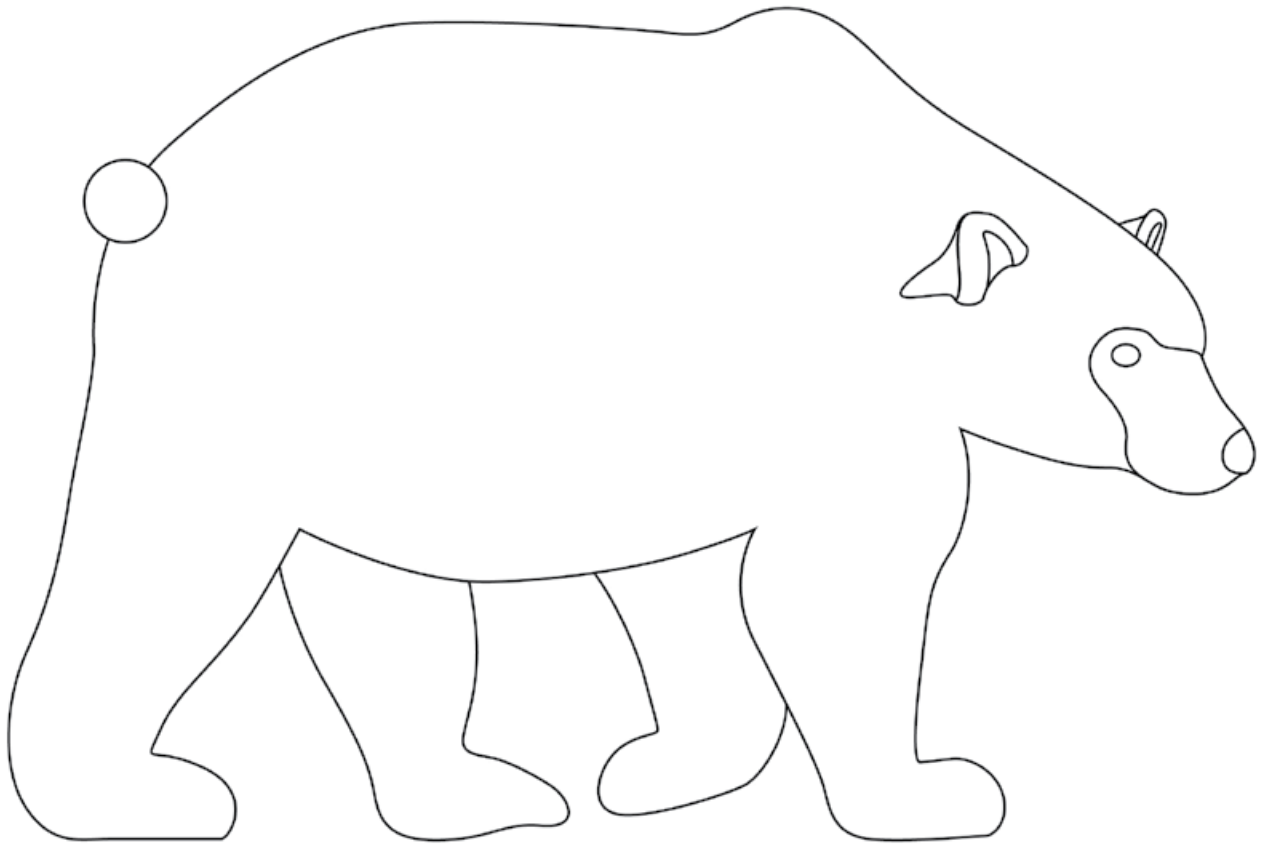

Ysbeer

Oefen om te skryf

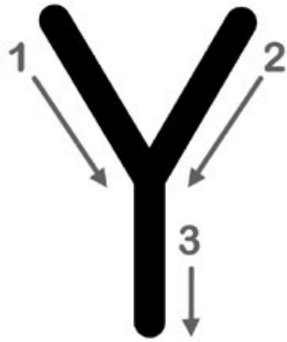

Zz

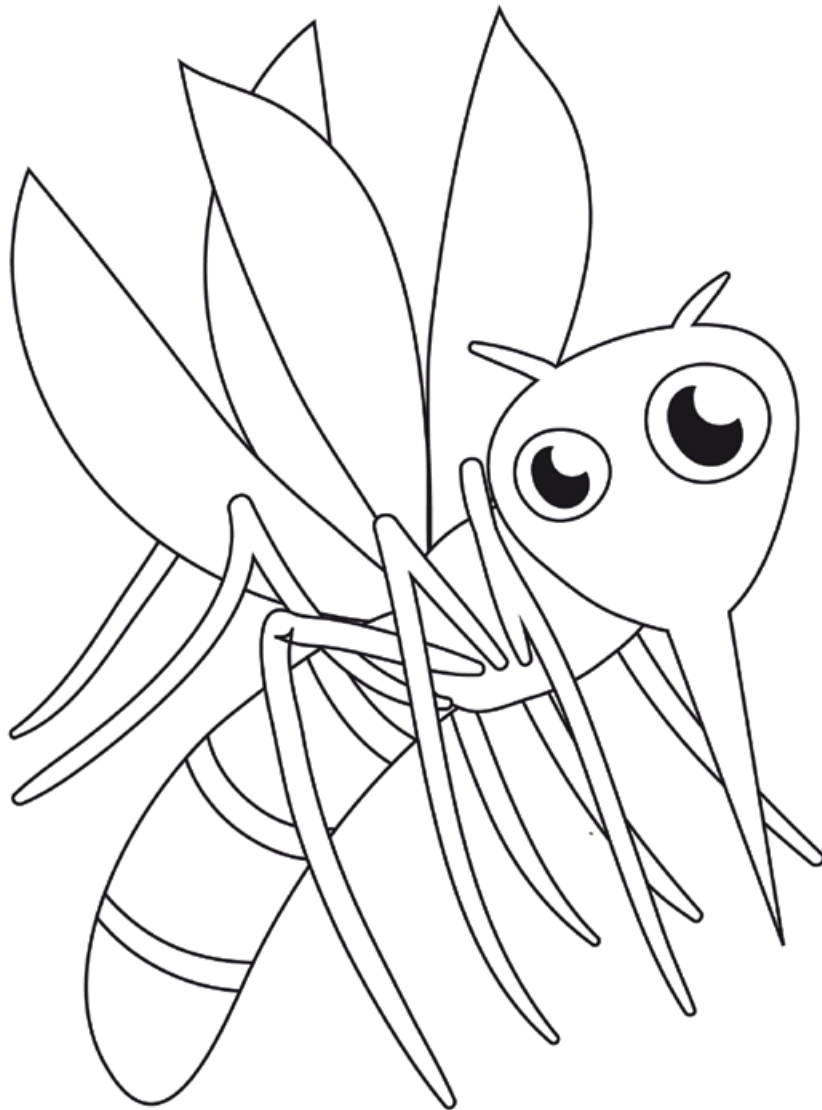

Zoem

Oefen om te skryf

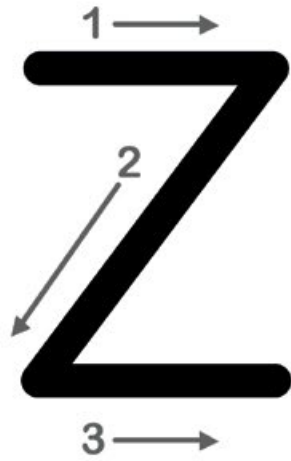

Voltooi die raaisel

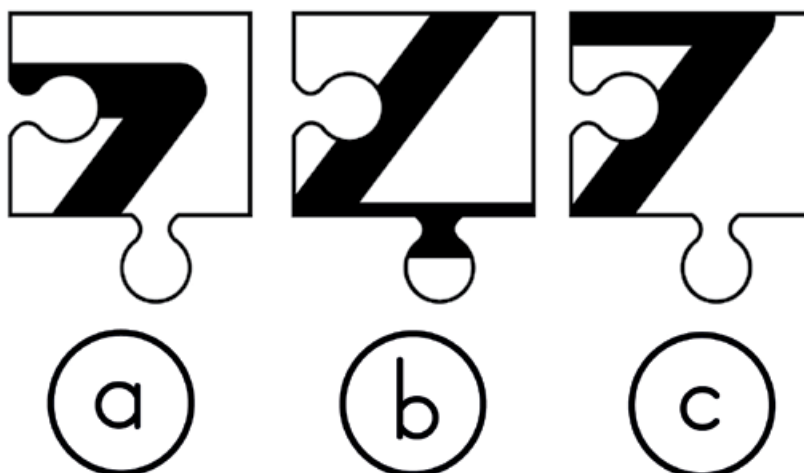
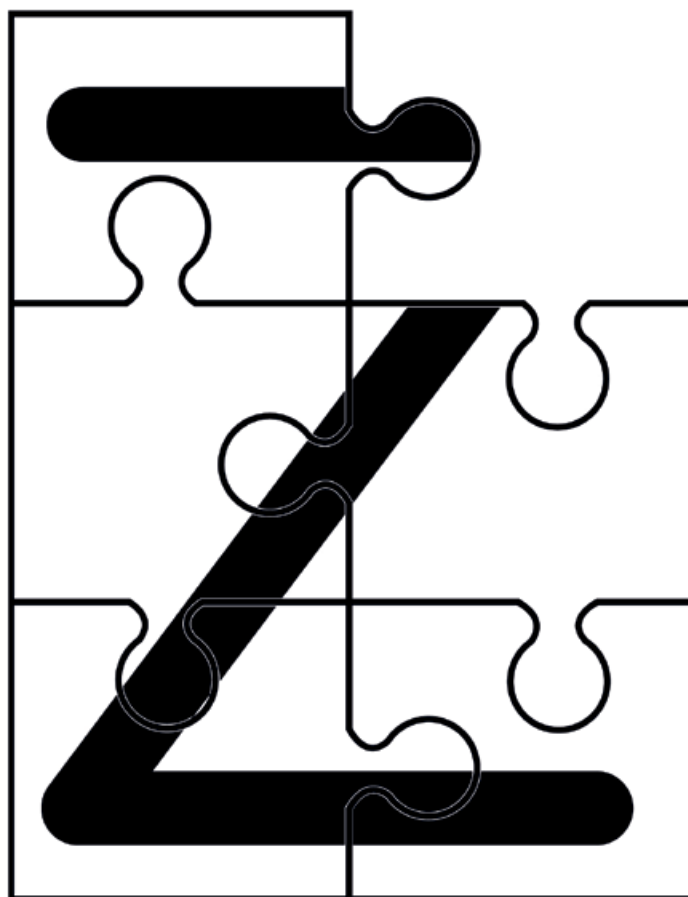

Antwoord: _____

Vul die ontbrekende letters in

A	B	C			F
G				K	
	N	O			R
	T			W	
	Z				

Vul die ontbrekende letters in

○ b c ○ e ○

○ h i j ○ ○

m ○ ○ ○ q r

s ○ ○ v ○ x

y ○