

Maak die syfer EEN



1



een

Oefen om te skryf

een een een een een

| | | | | | | | | |

een

|

Oefen om te tel

een blom

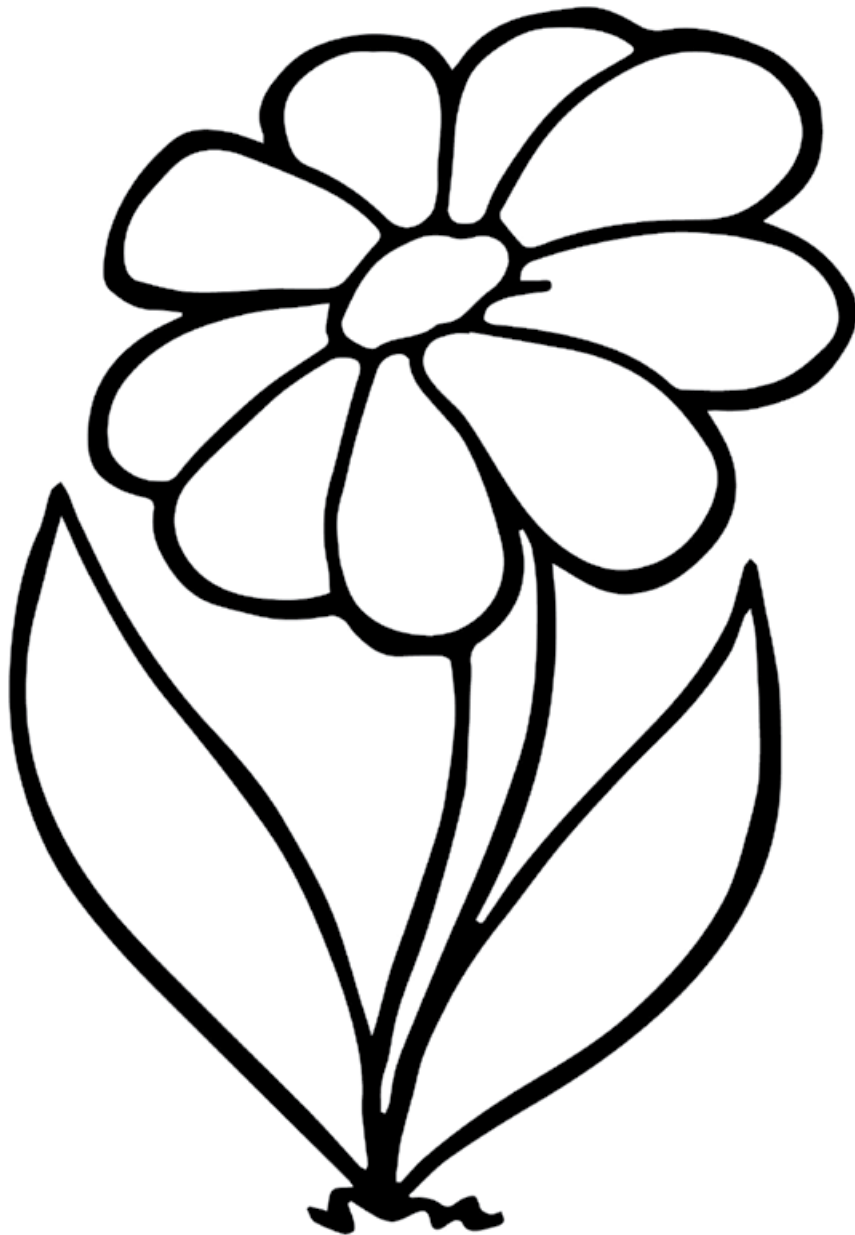

Maak die syfer TWEE

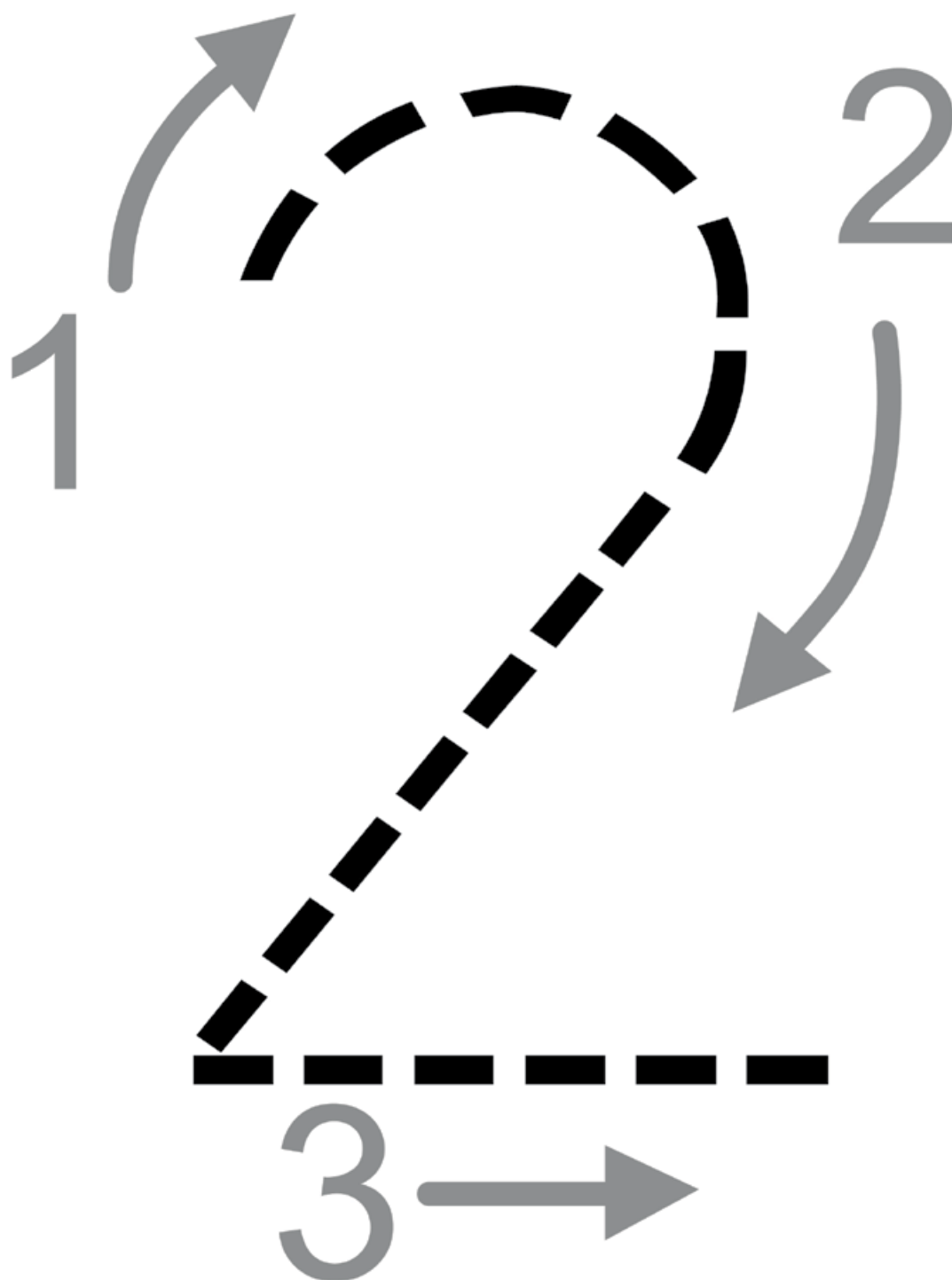

2

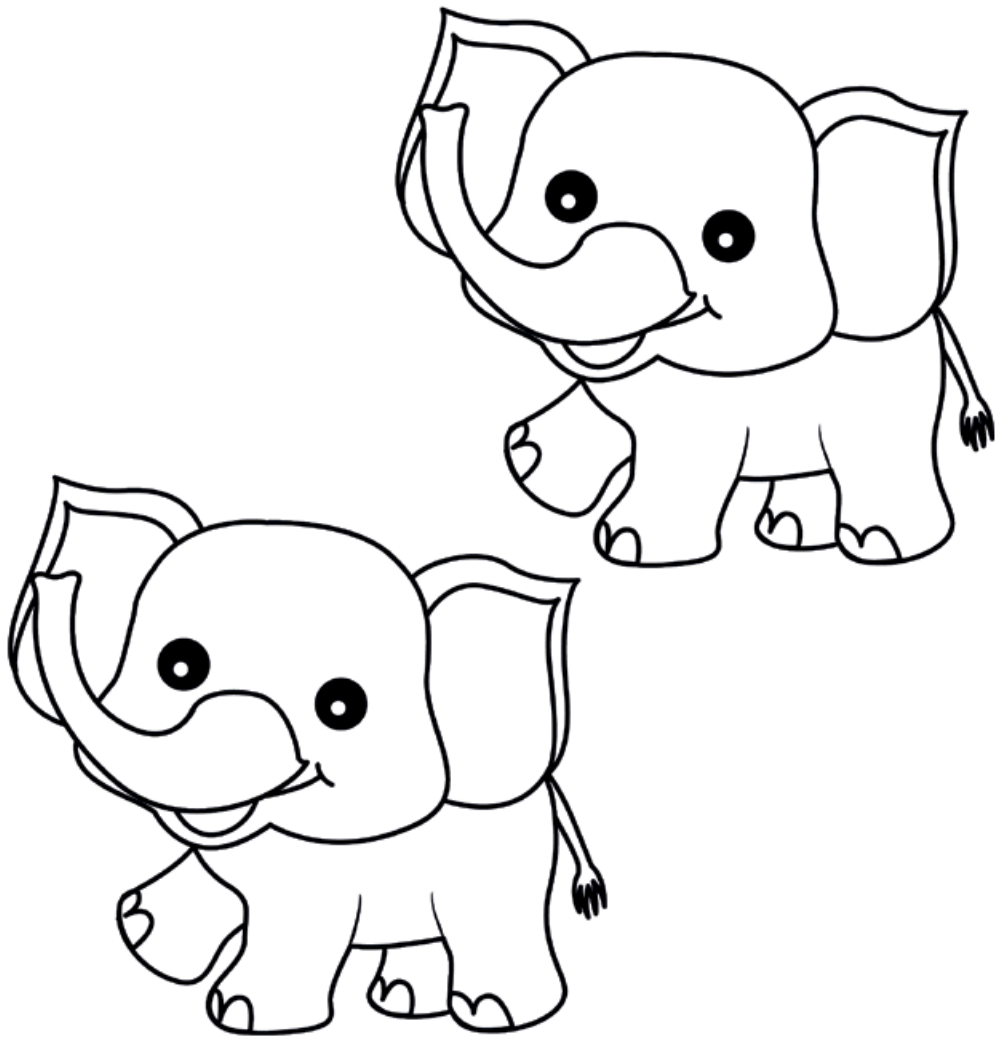

twée

Oefen om te skryf

twee twee twee twee

2 2 2 2 2 2 2 2 2 2

twee

2

Oefen om te tel

twee skoene



Maak die syfer DRIE

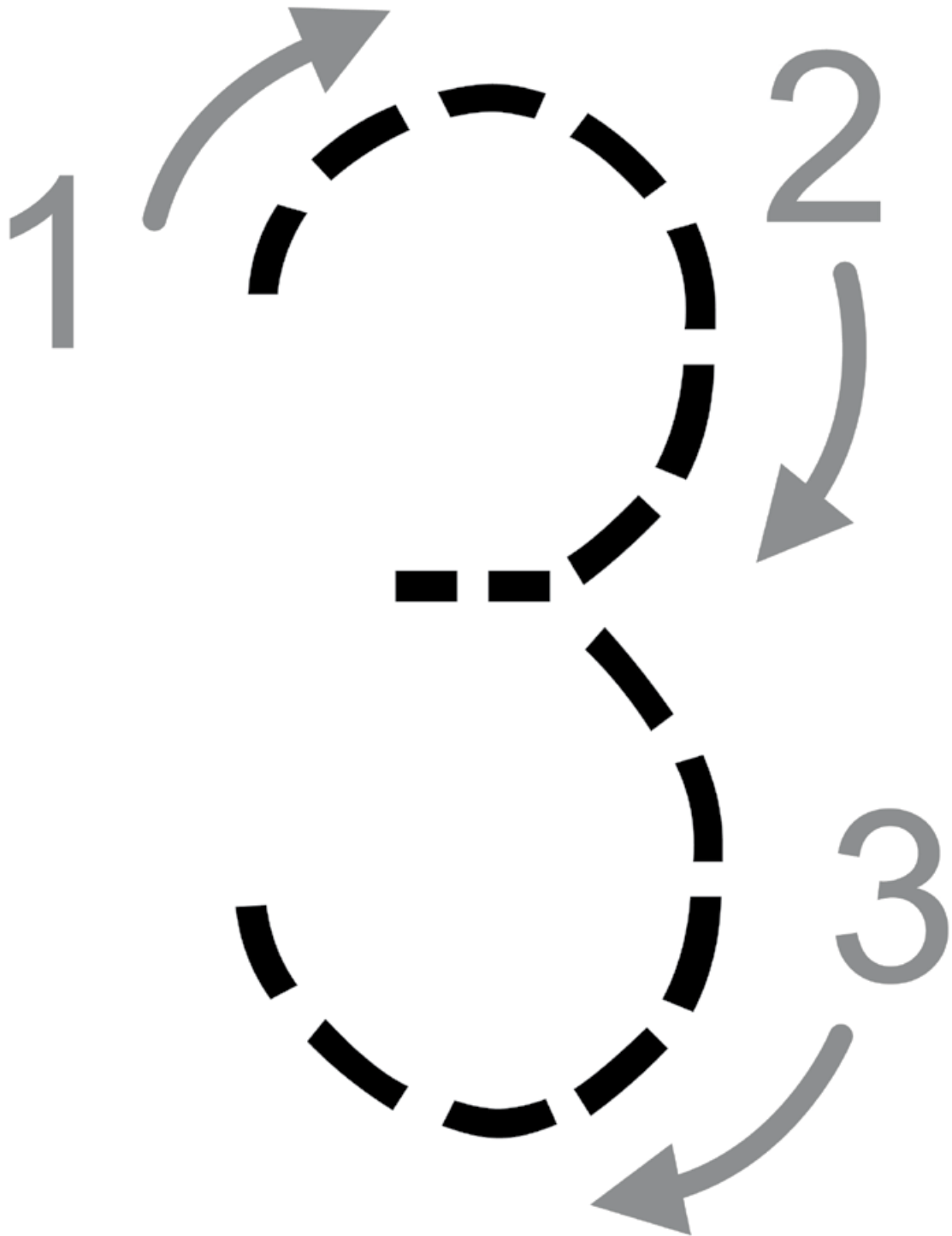

3

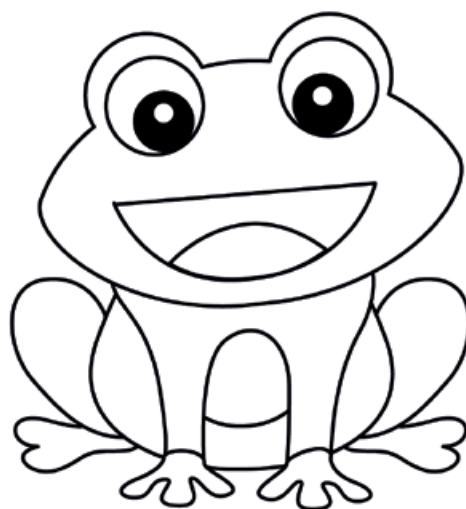
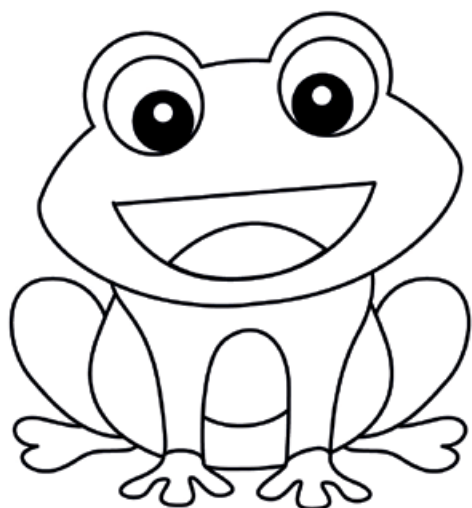
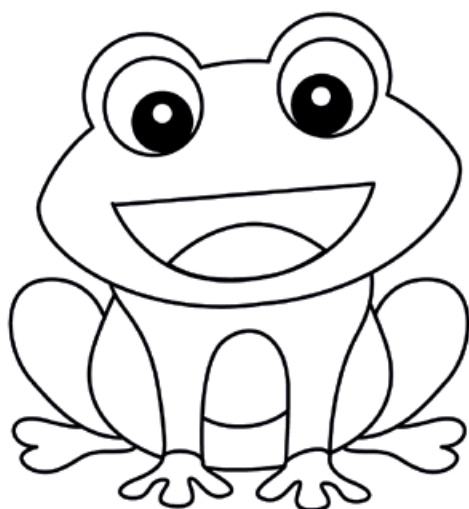

drie

Oefen om te skryf

drie drie drie drie

3 3 3 3 3 3 3 3 3 3 3

drie

3

Oefen om te tel

drie eiers

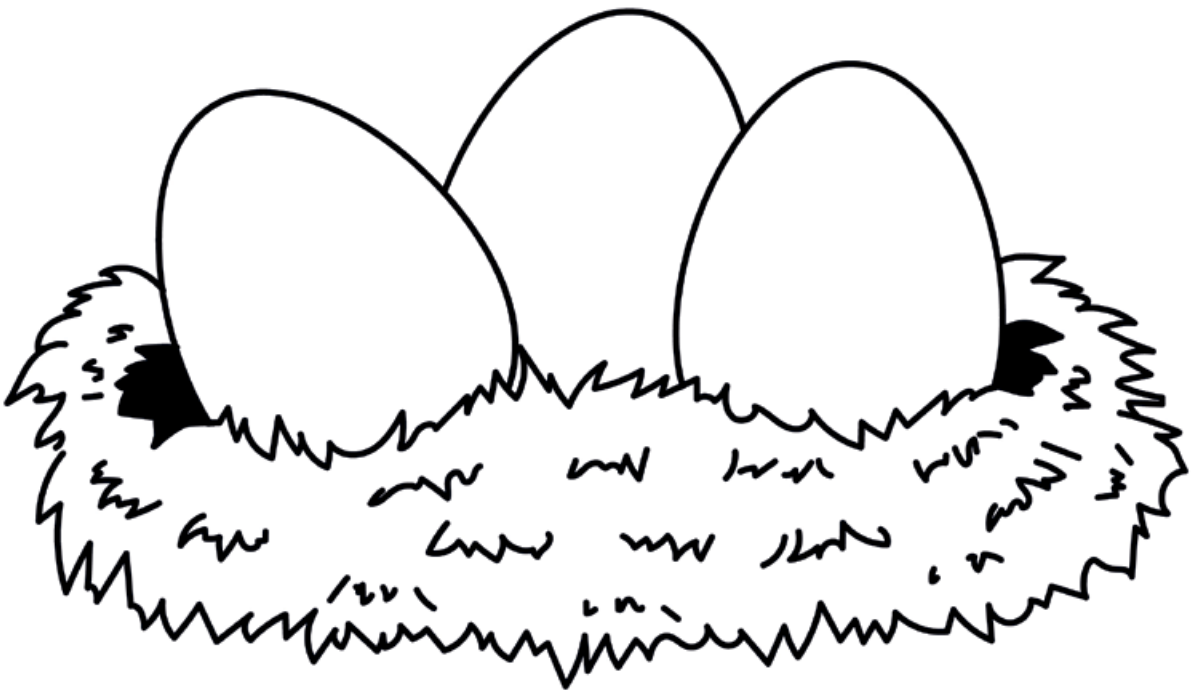

Maak die syfer VIER

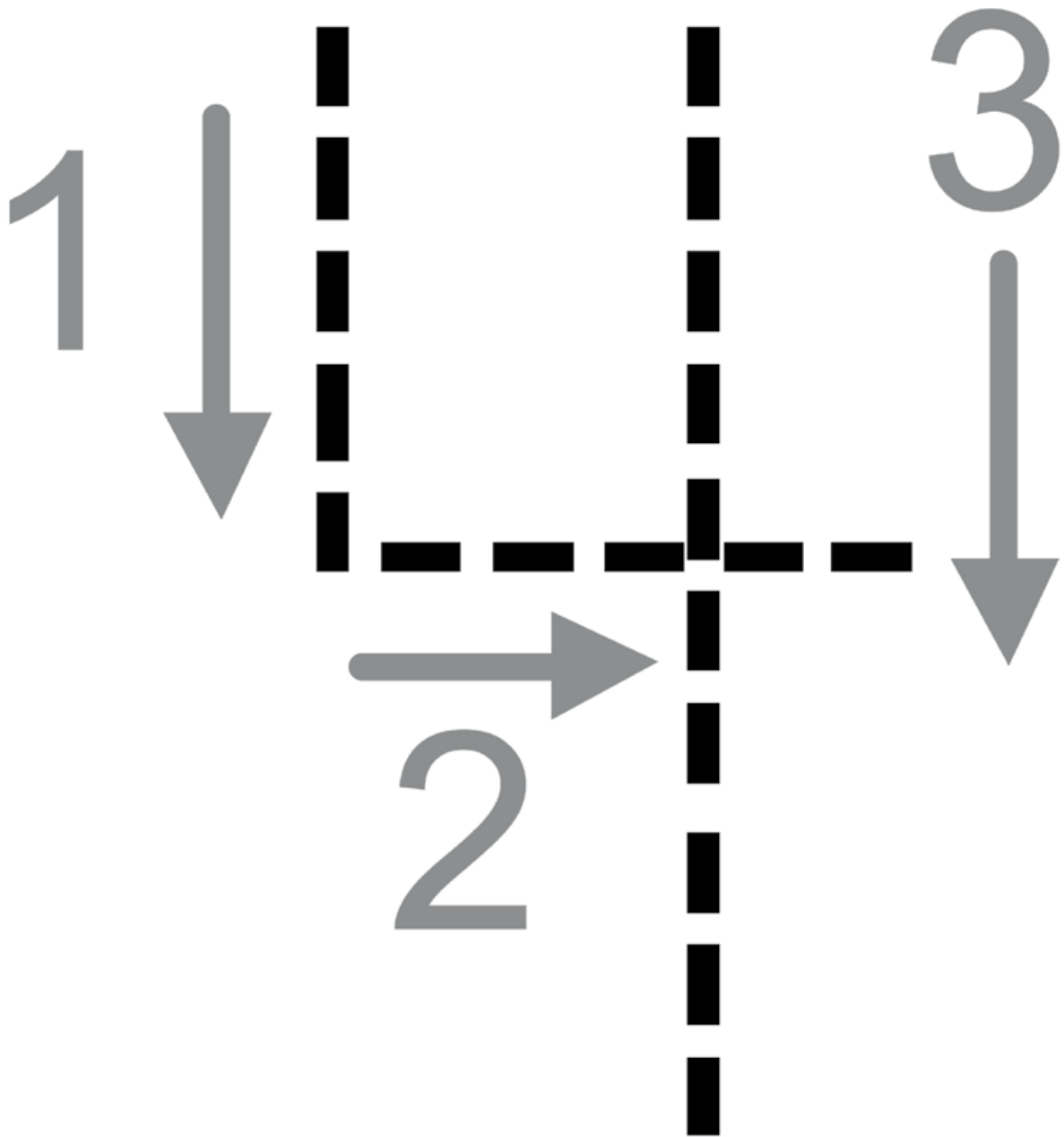

4

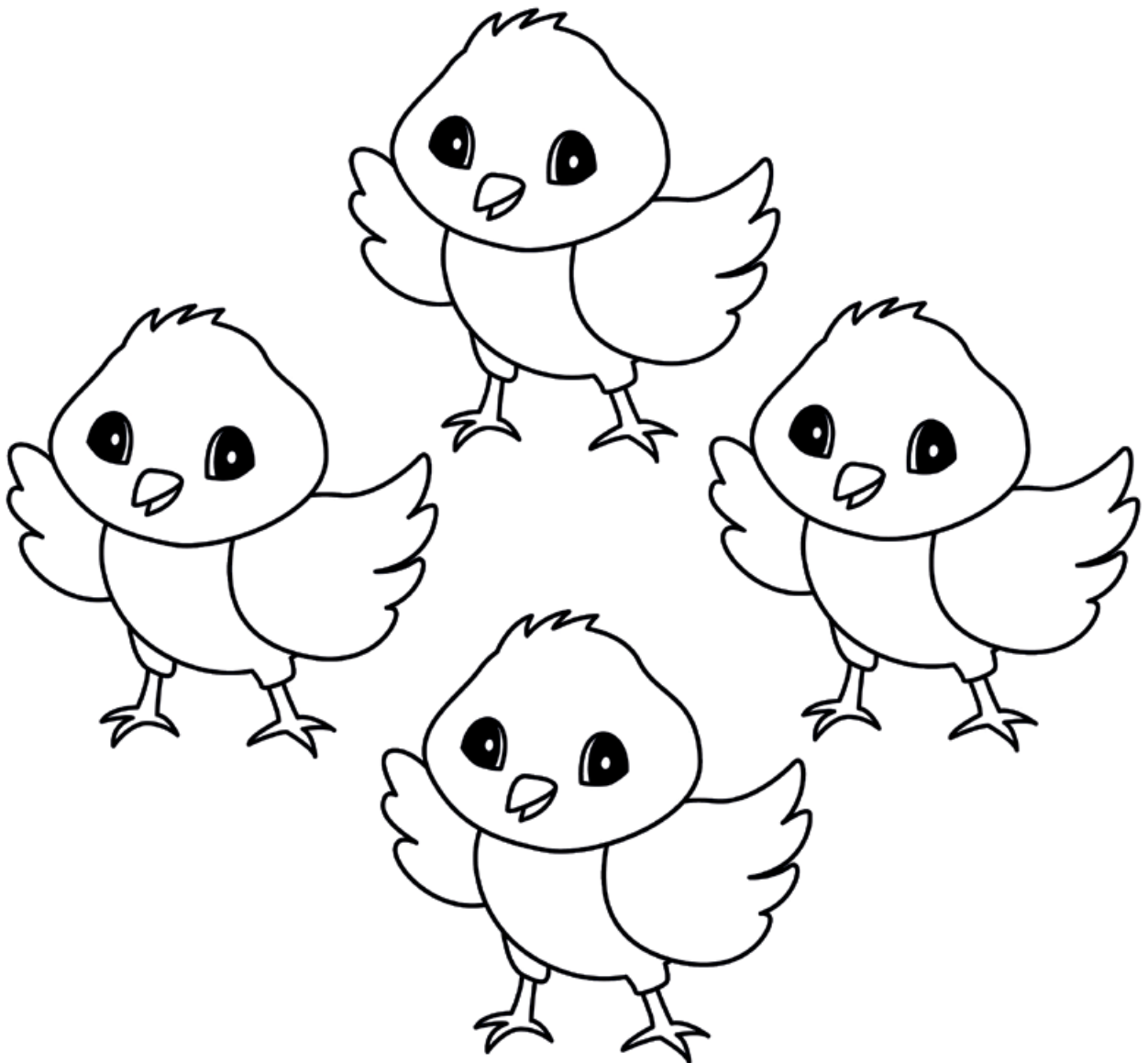

vier

Oefen om te skryf

vier vier vier vier

4 4 4 4 4 4 4 4 4 4 4

vier

4

Oefen om te tel

vier hoede

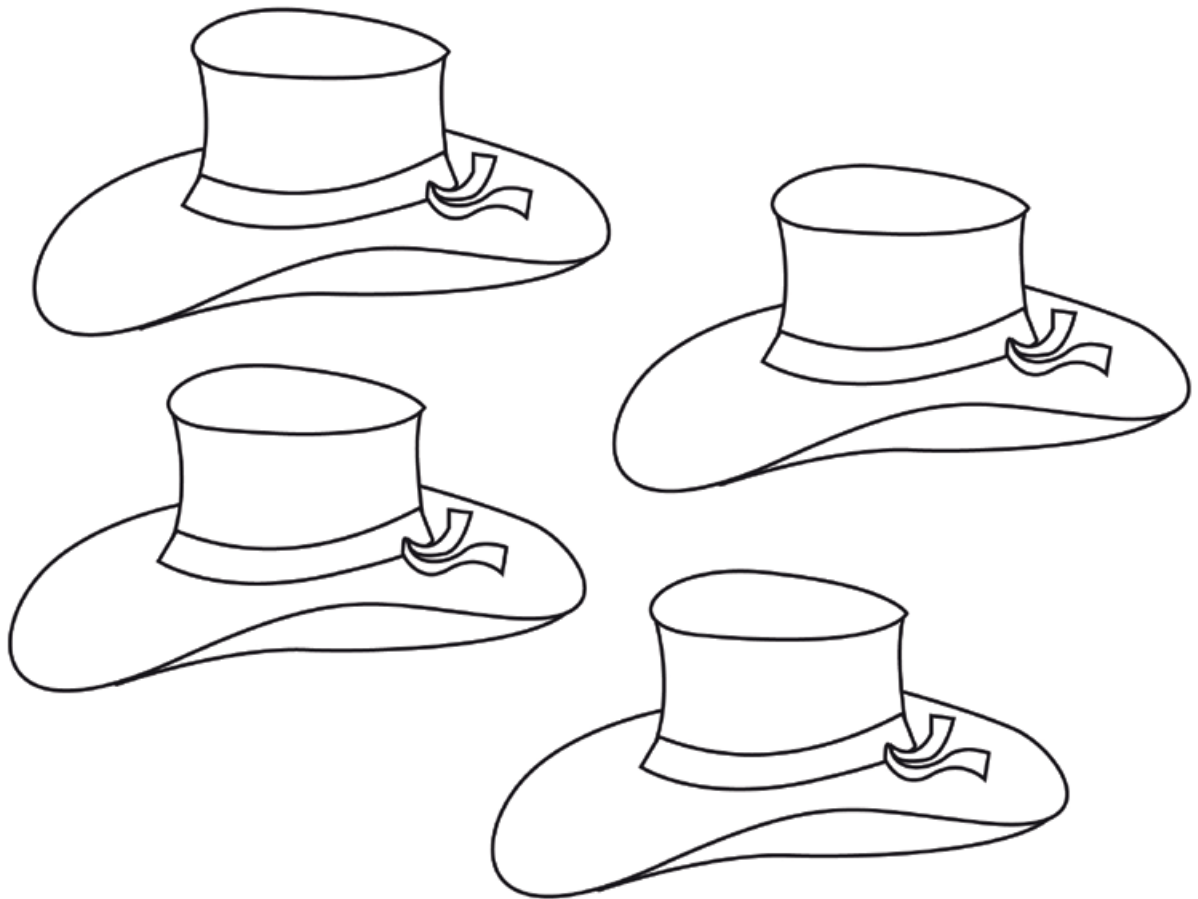

Maak die syfer VYF

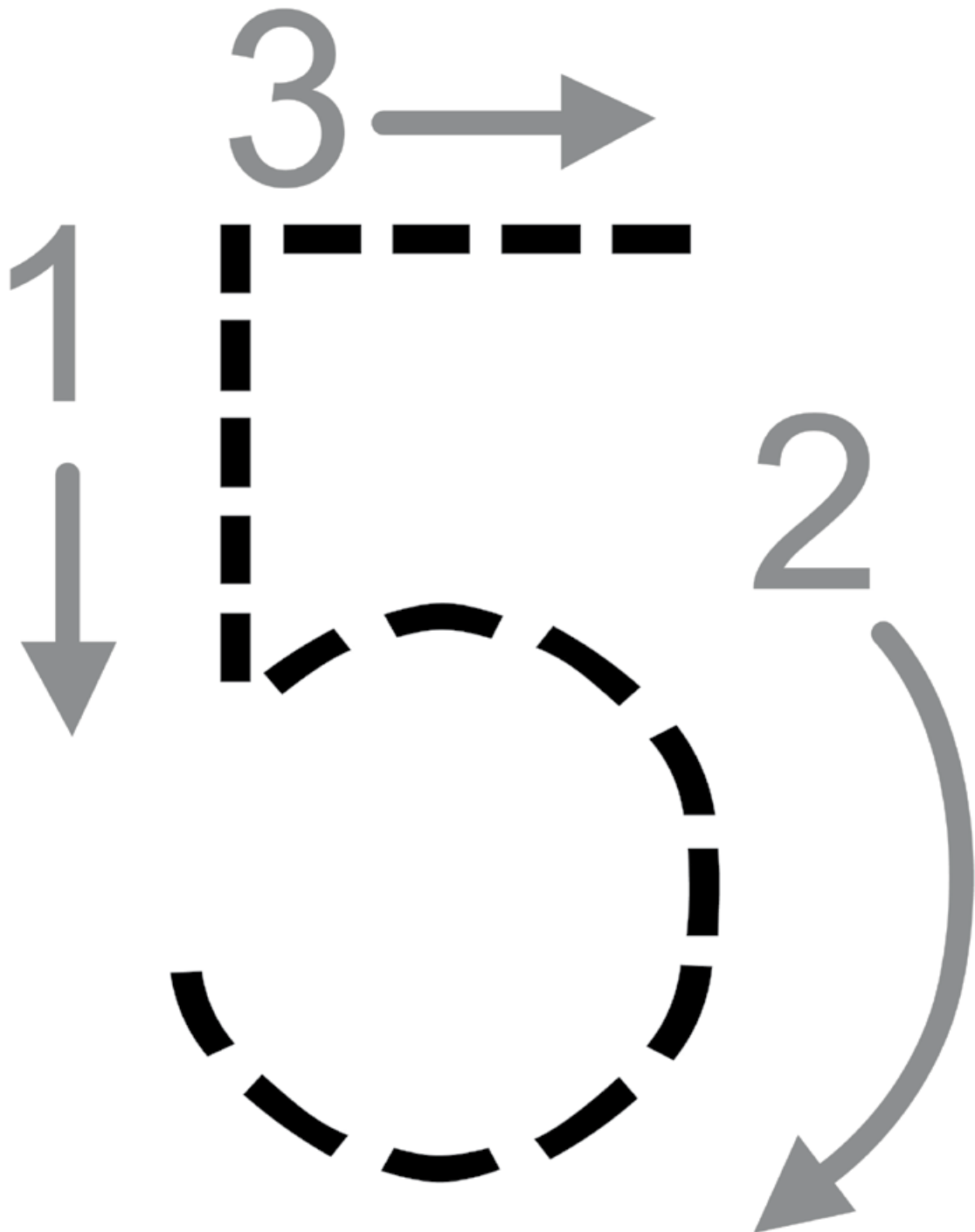

5

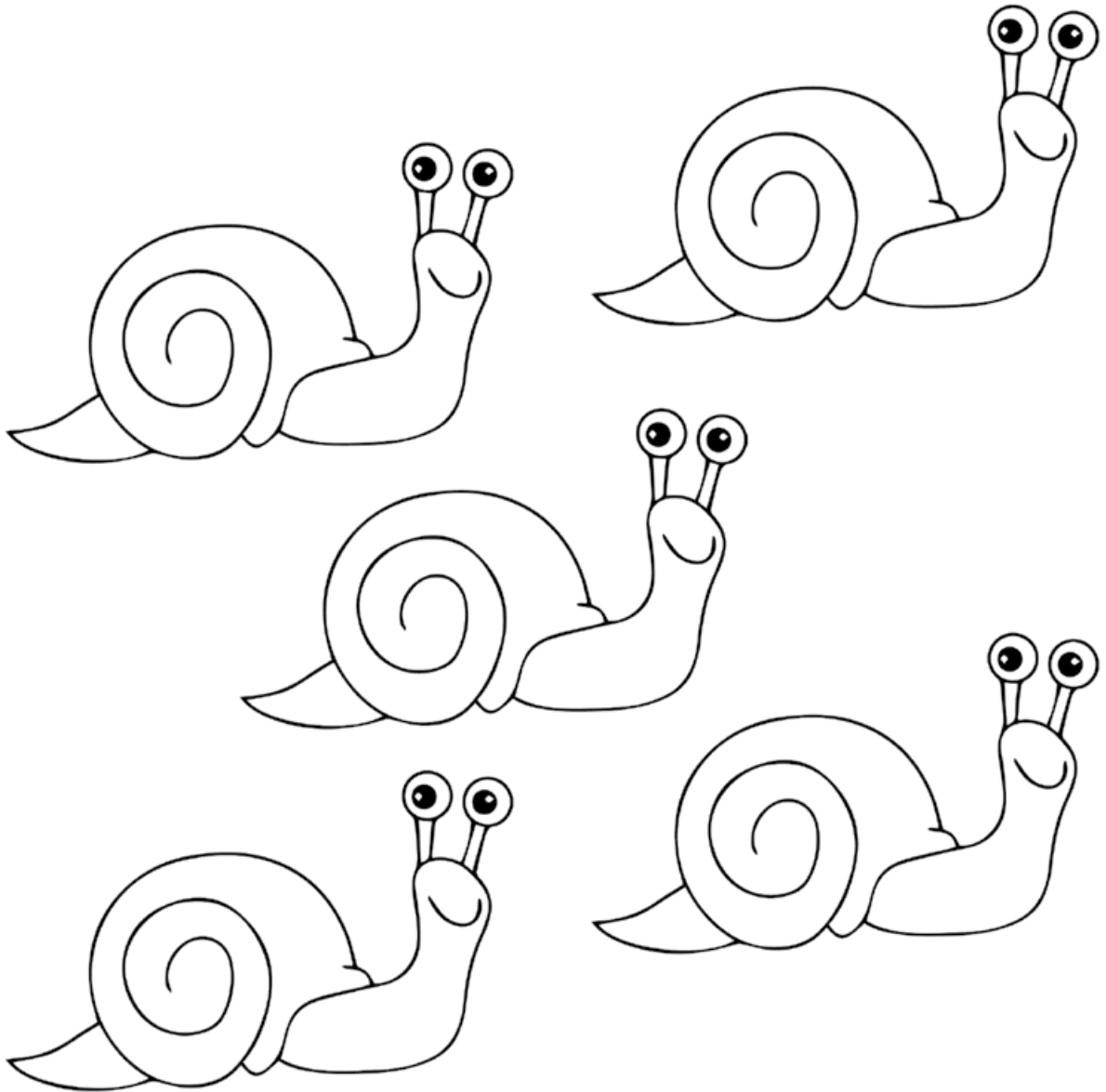

vyf

Oefen om te skryf

vyf vyf vyf vyf vyf

5 5 5 5 5 5 5 5 5 5 5

vyf

5 5 5 5 5 5 5 5 5 5 5

Oefen om te tel

vyf appels

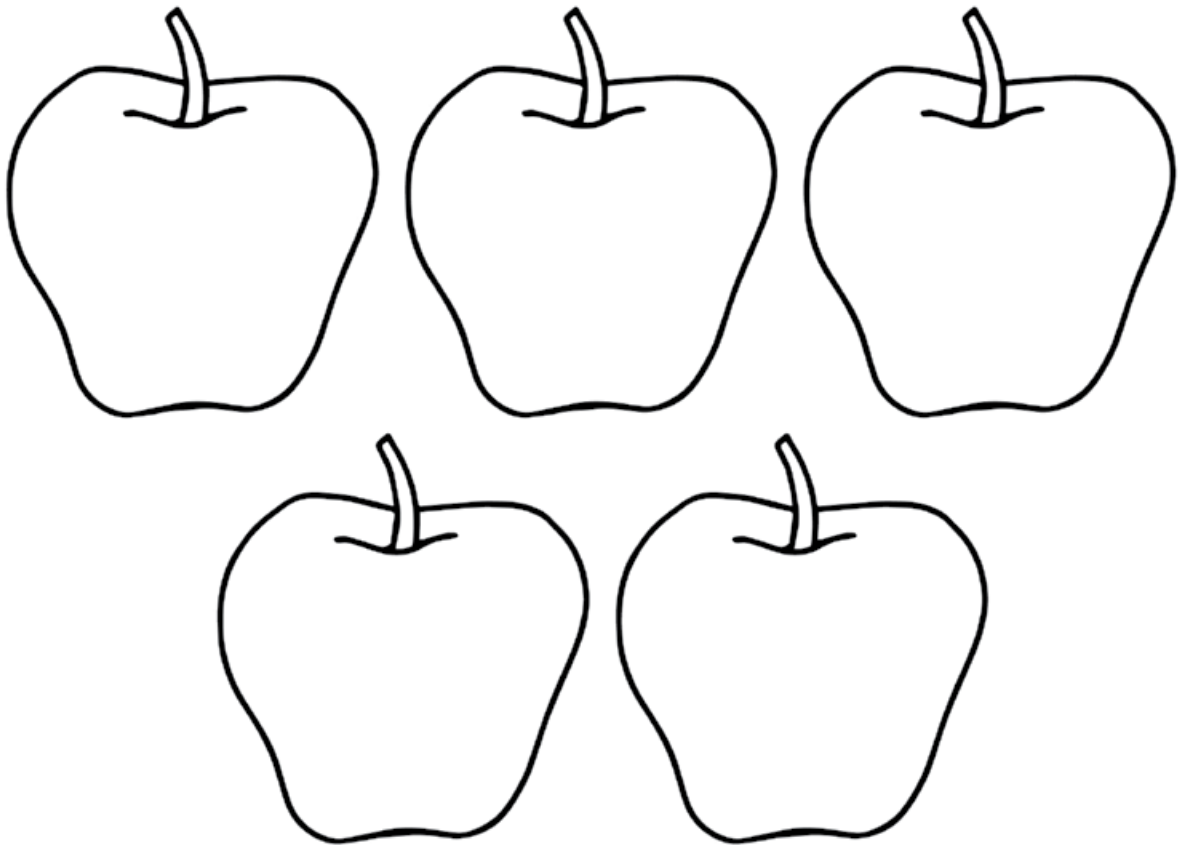

Maak die syfer SES

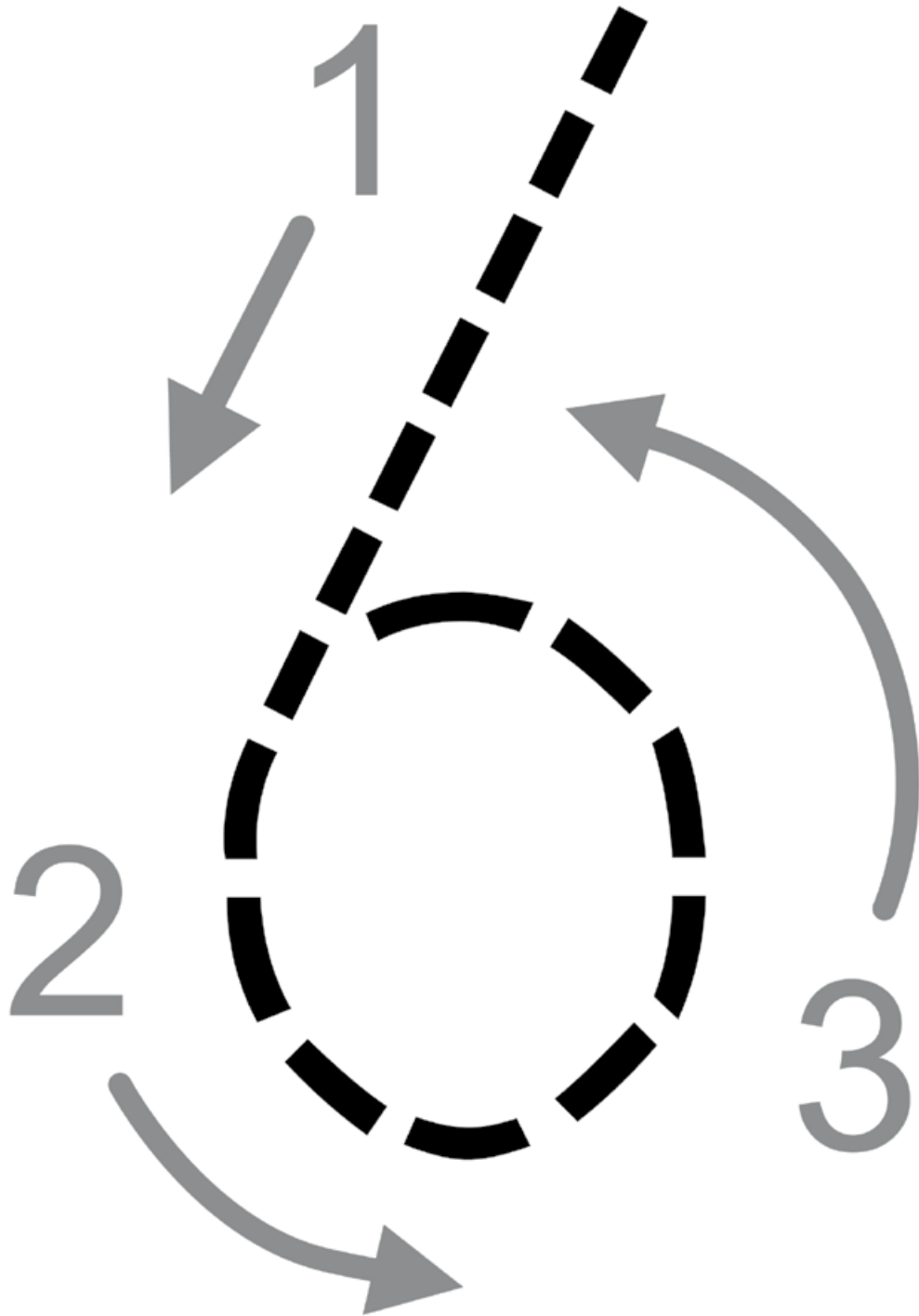

6



ses

Oefen om te skryf

ses ses ses ses ses

6 6 6 6 6 6 6 6 6 6 6 6

ses

6

Oefen om te tel

ses

visse

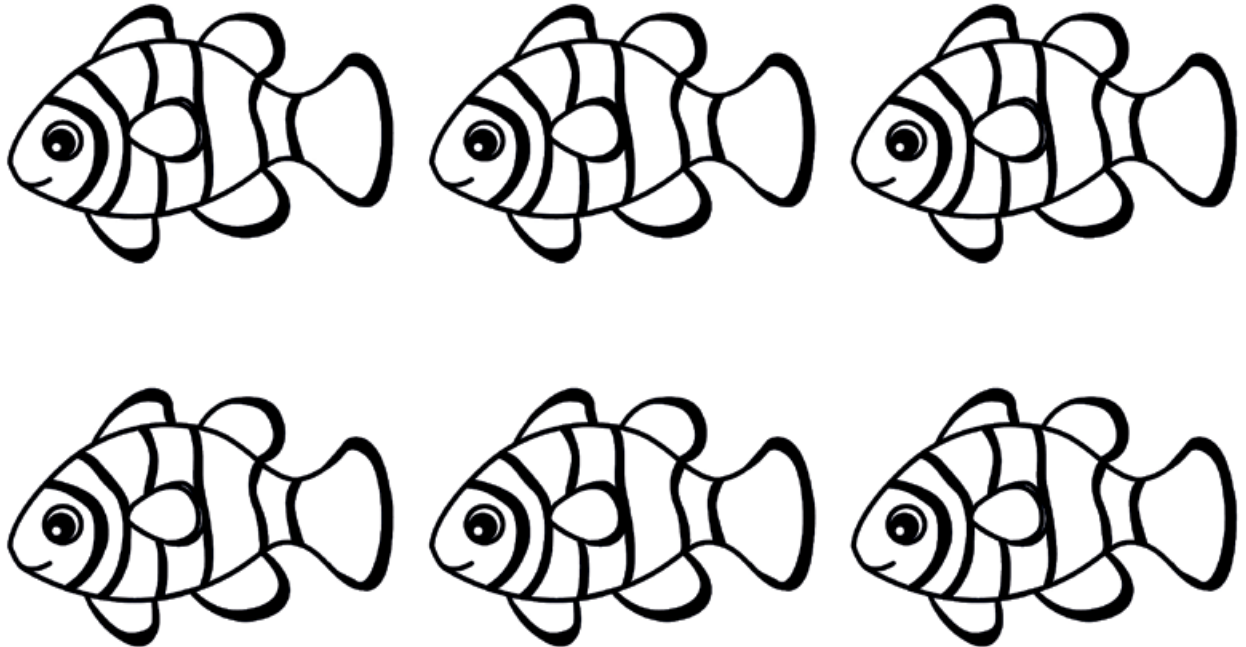

Maak die syfer SEWE

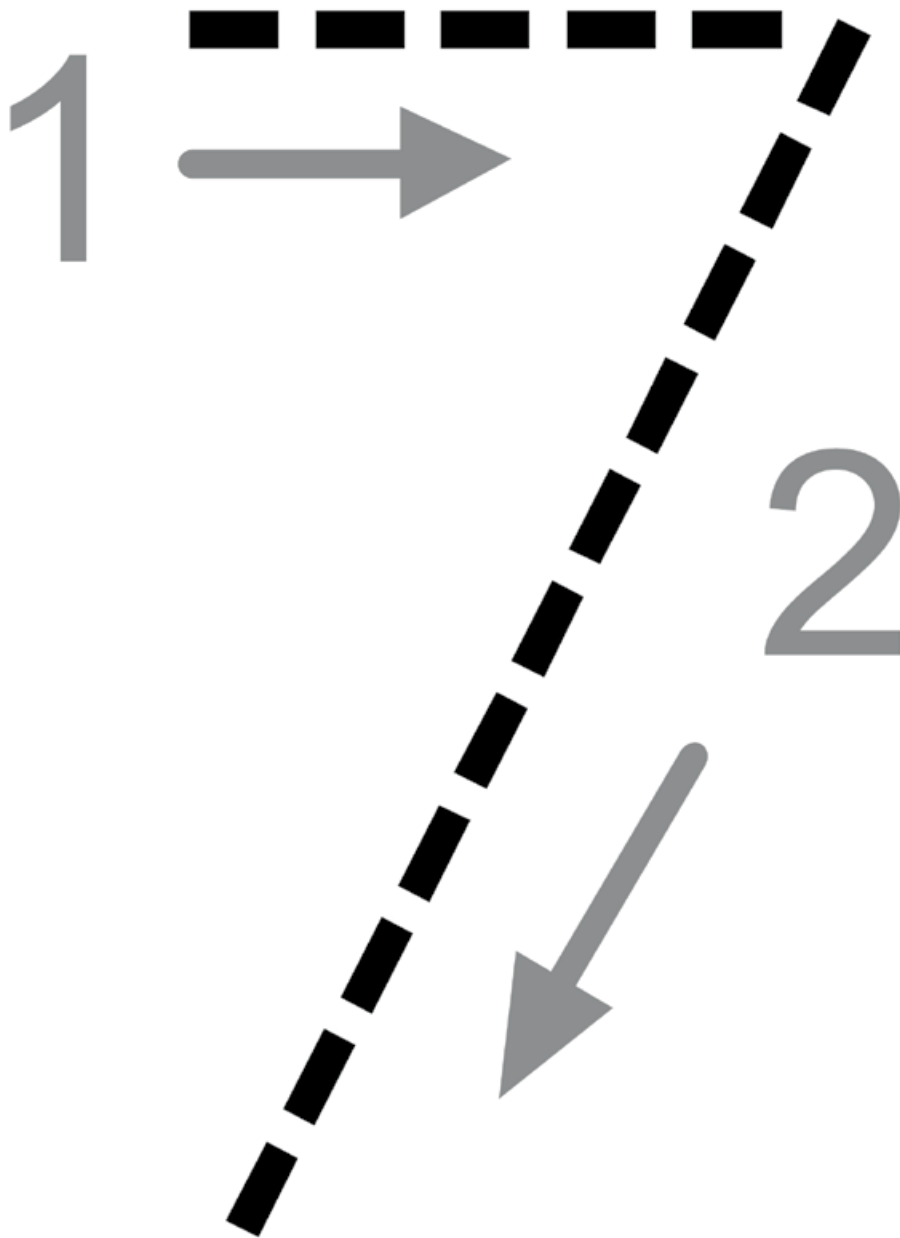

7

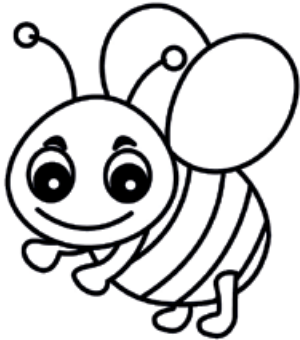

sewe

Oefen om te skryf

sewe sewe sewe sewe

7 7 7 7 7 7 7 7 7 7

sewe

7

Oefen om te tel

sewe

balle



Maak die syfer AGT

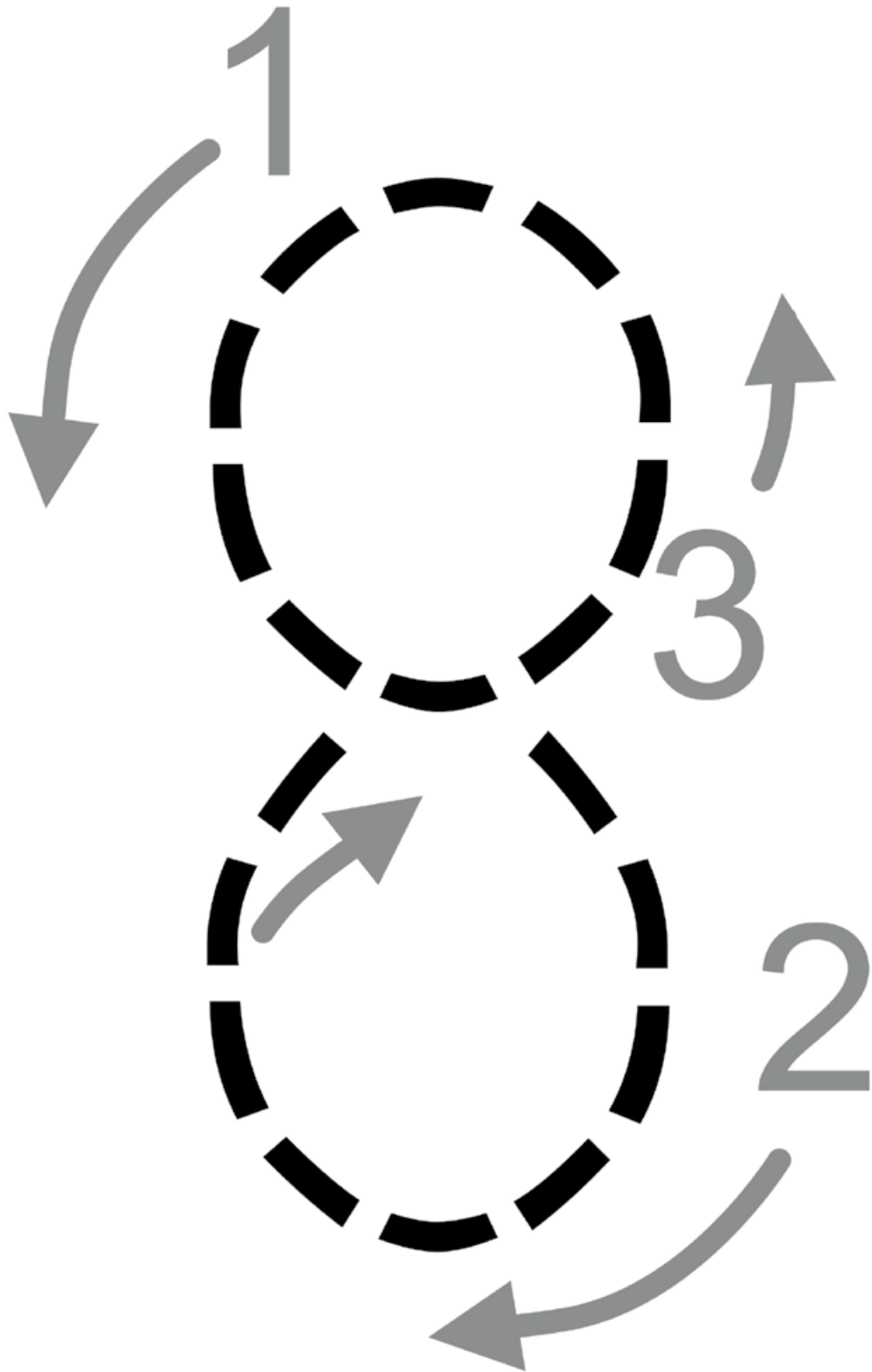

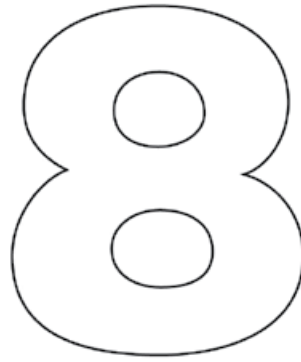

agt

Oefen om te skryf

agt agt agt agt agt

8 8 8 8 8 8 8 8 8 8 8 8

agt

8

Oefen om te tel

agt wolke

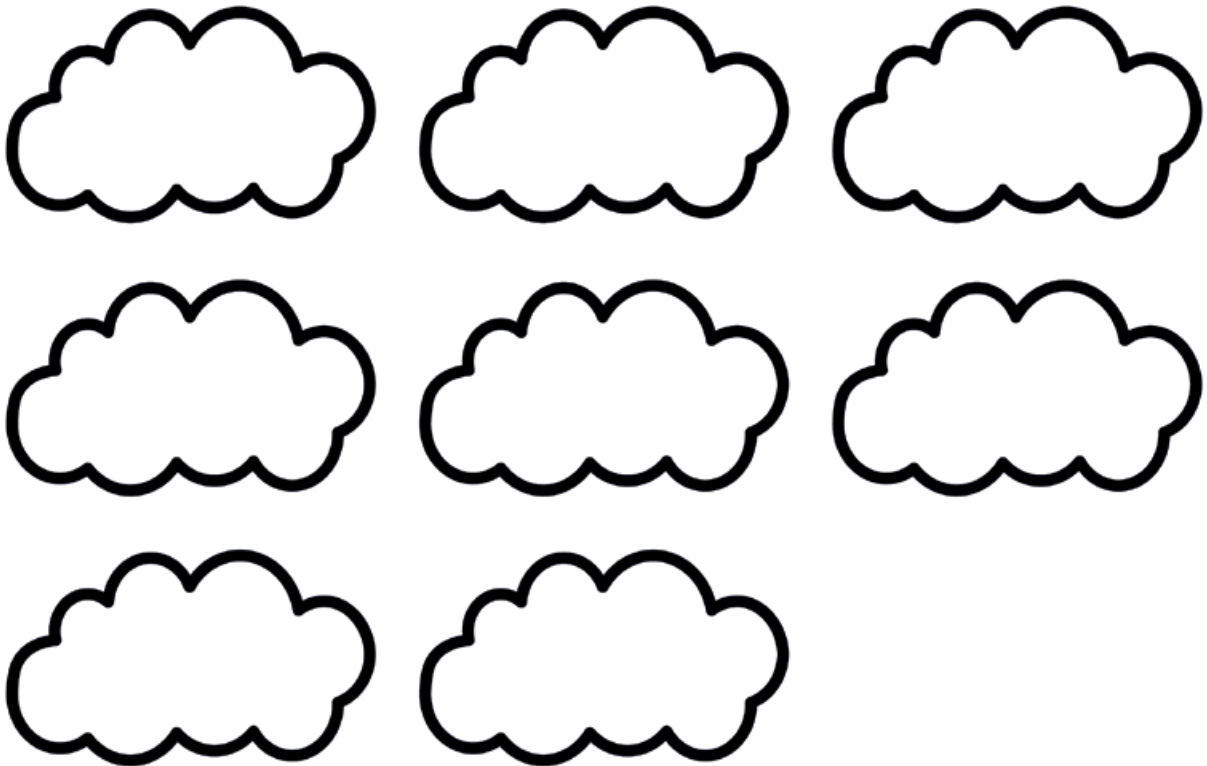

Maak die syfer NEGE

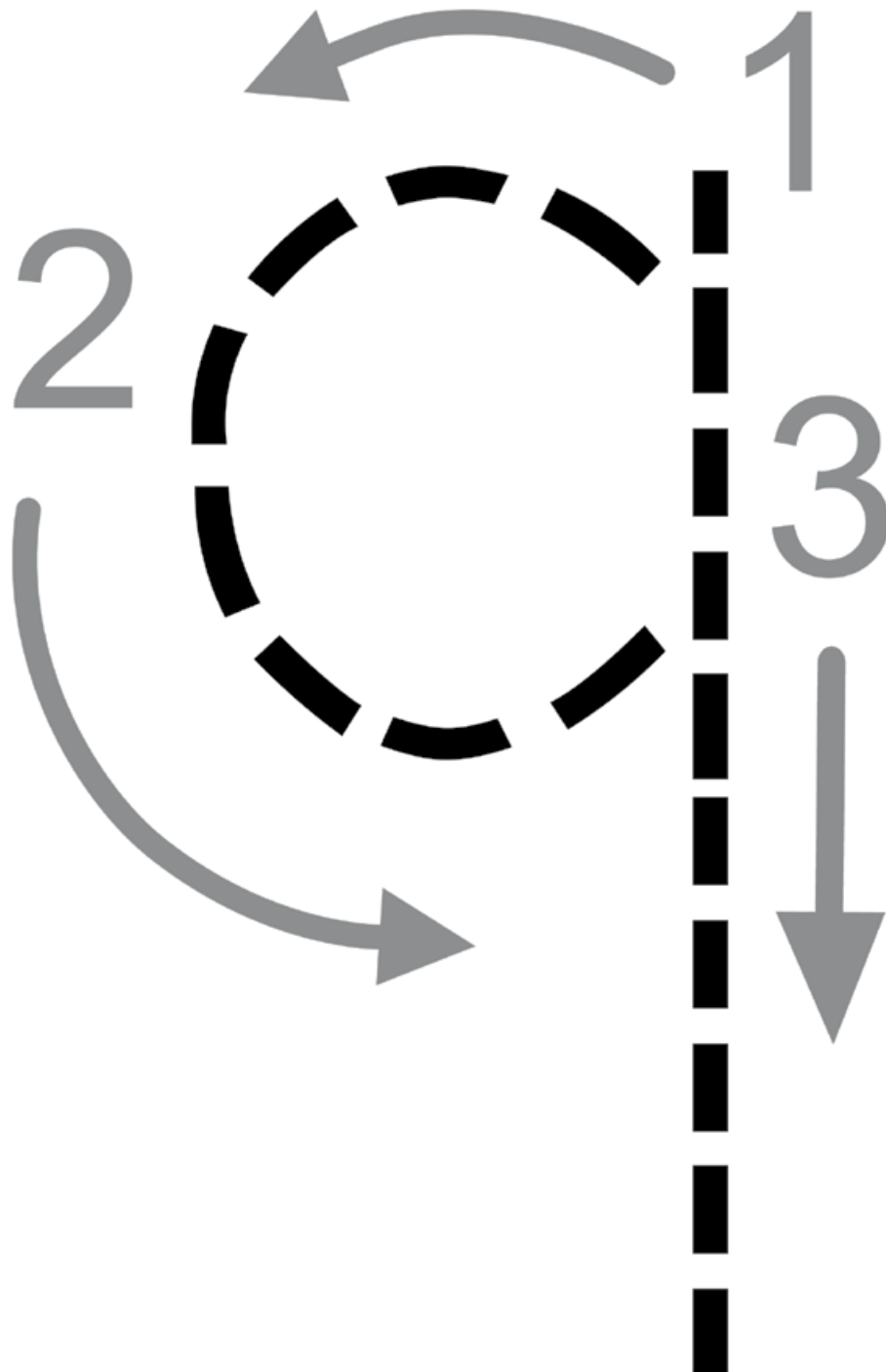

9

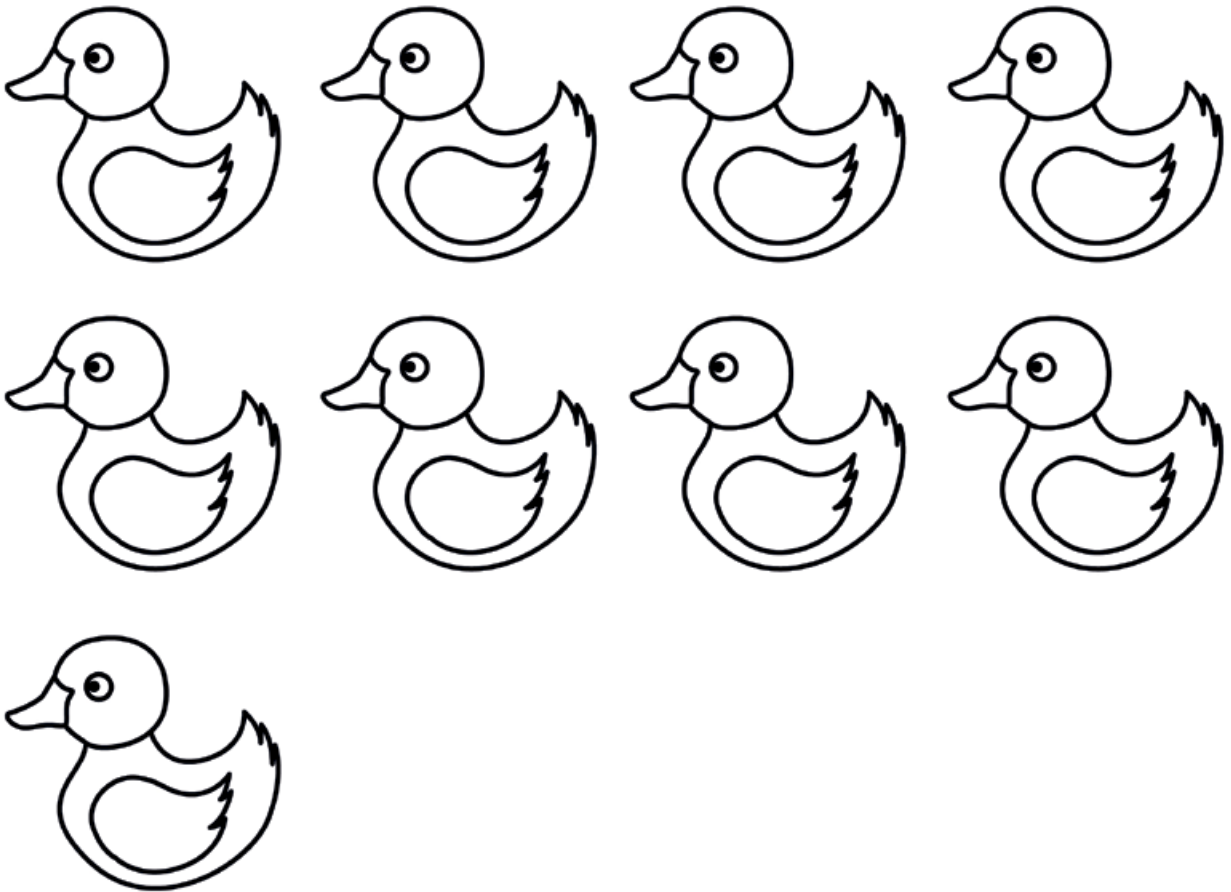

nege

Oefen om te skryf

nege nege nege

q q q q q q q q q q q

nege

q

Oefen om te tel

nege roomyse



Maak die syfer TIEN

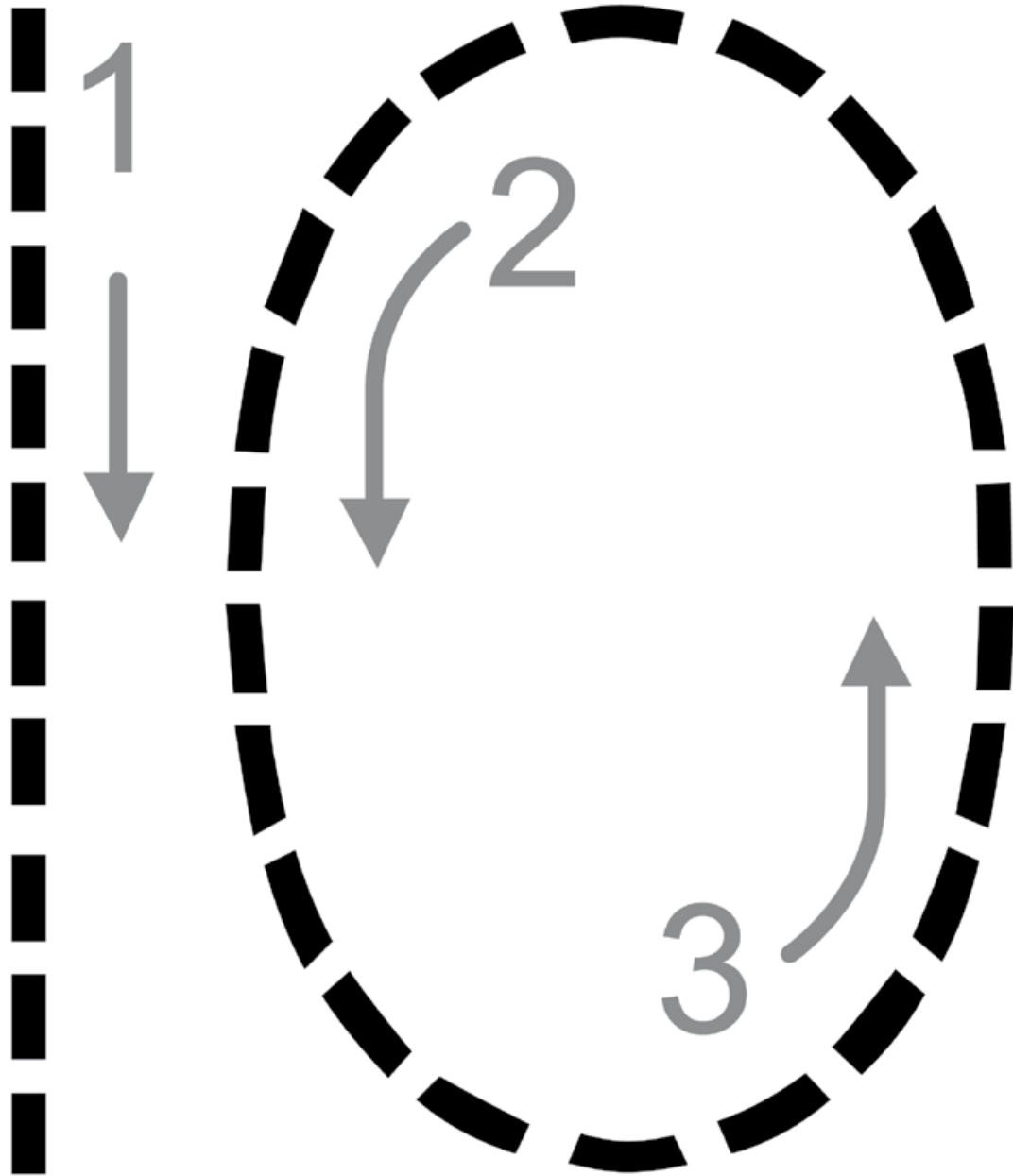

10

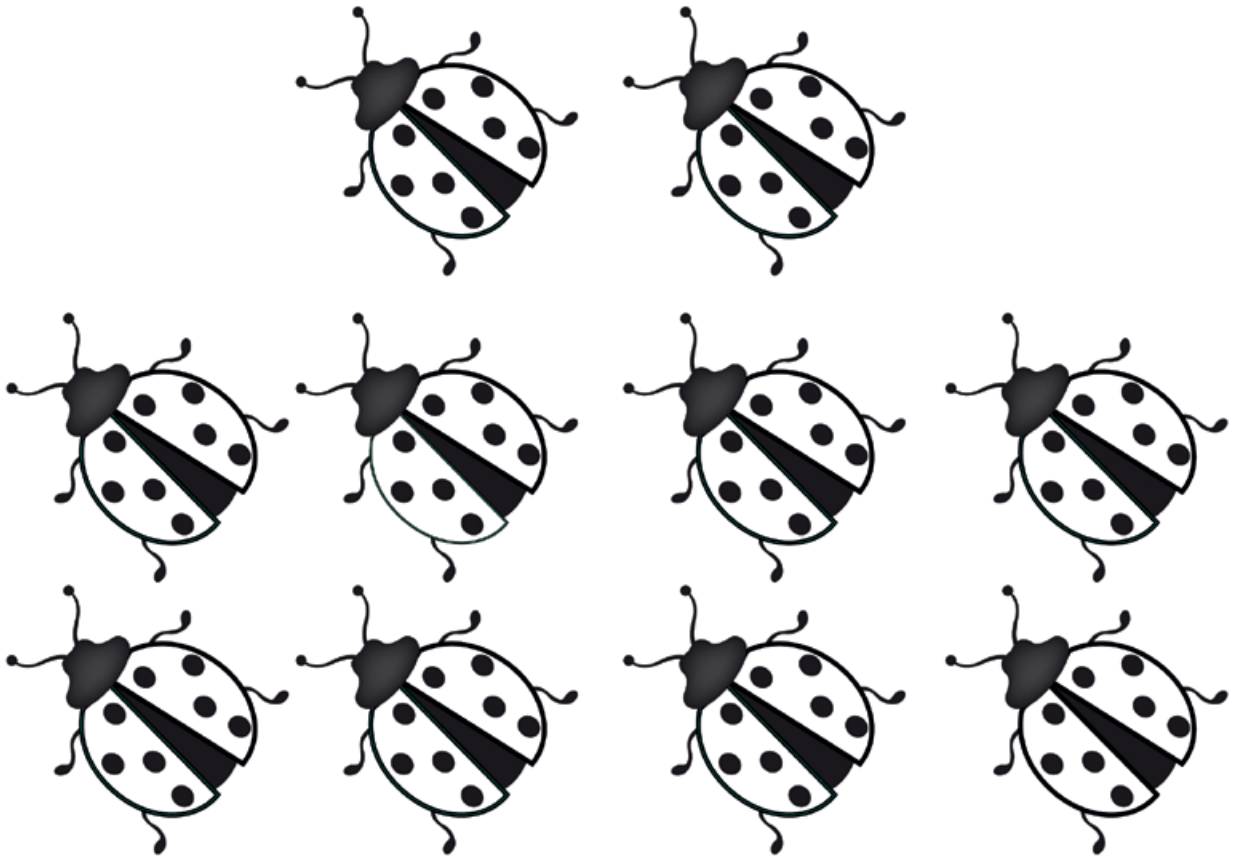

tien

Oefen om te skryf

tien tien tien tien

10 10 10 10 10 10 10

tien

10

Oefen om te tel

_____ tien _____ sonne

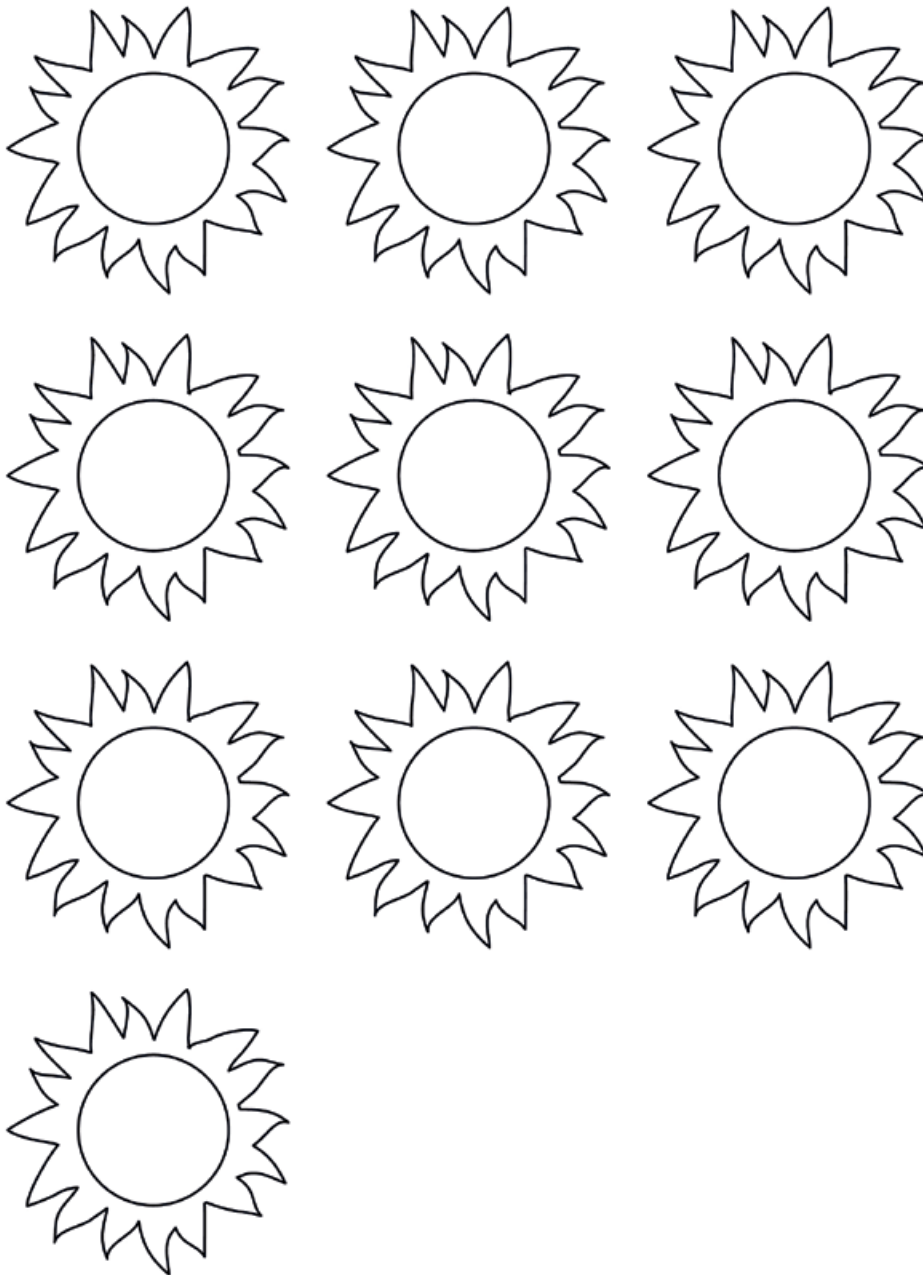

Kol tot kol

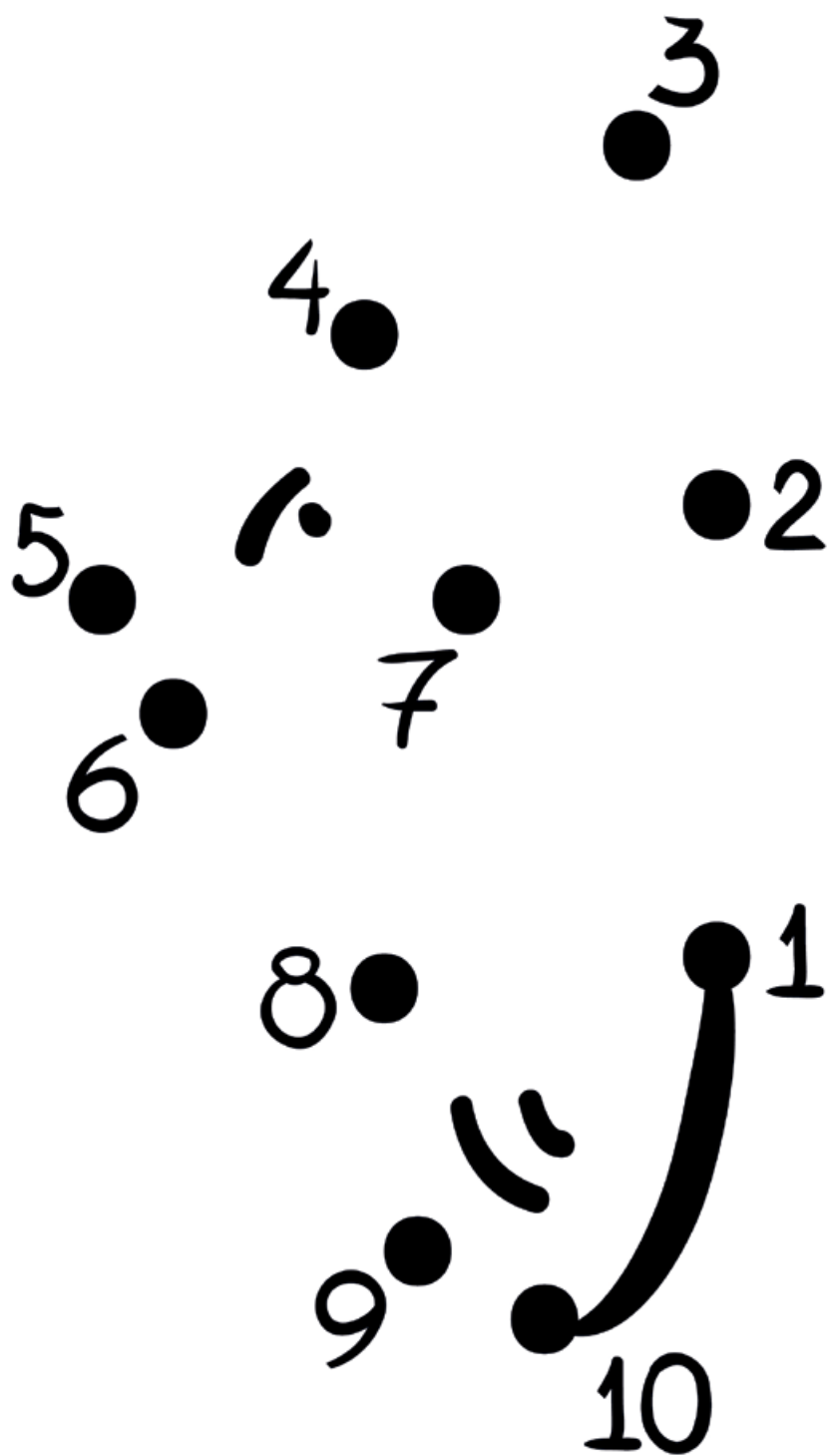



Kleur in volgens die syfers



1 - ligblou 2 - blou 3 - groen 4 - donkergroen
5 - geel 6 - oranje 7 - bruin

Deurmekaar pret

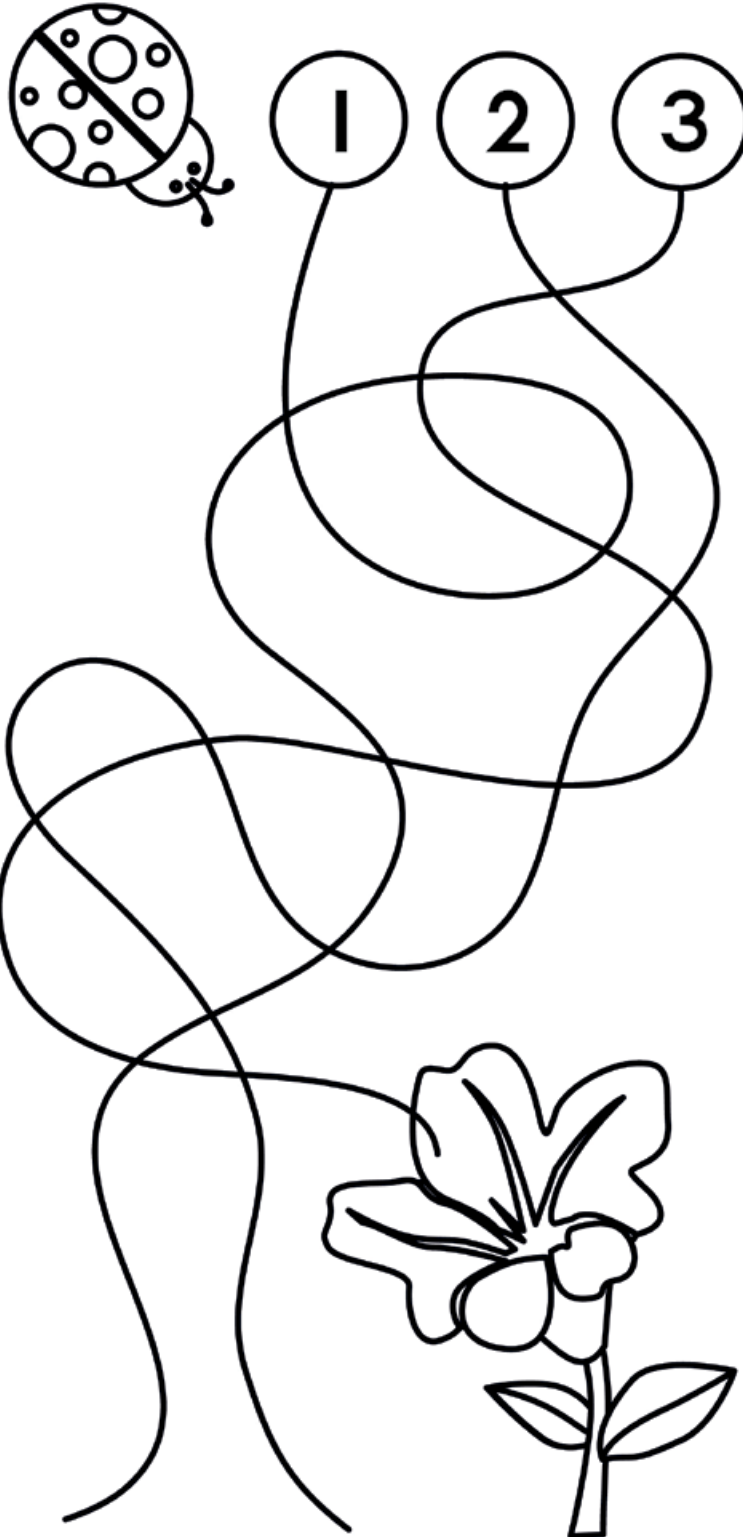

Kol tot kol

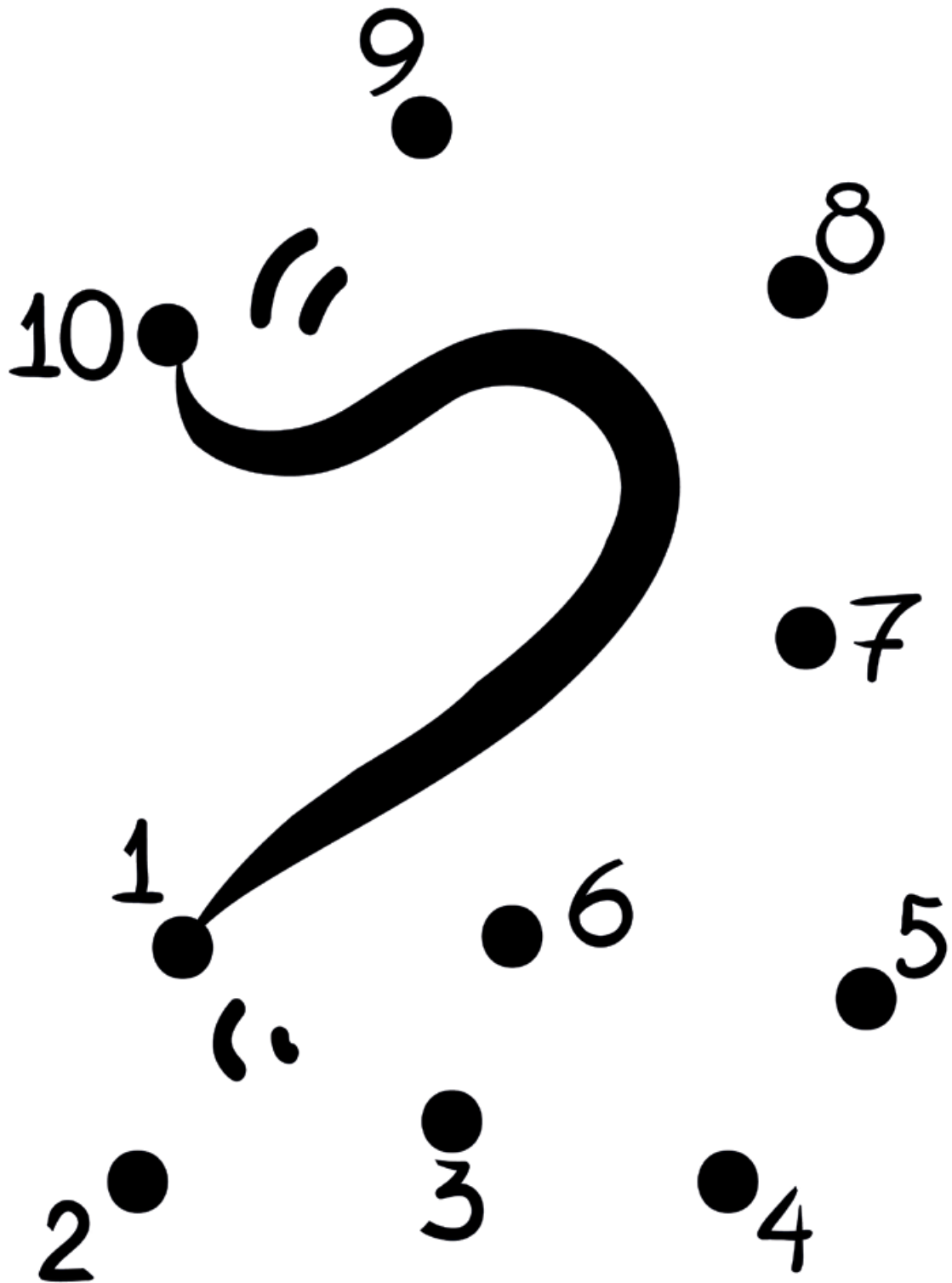

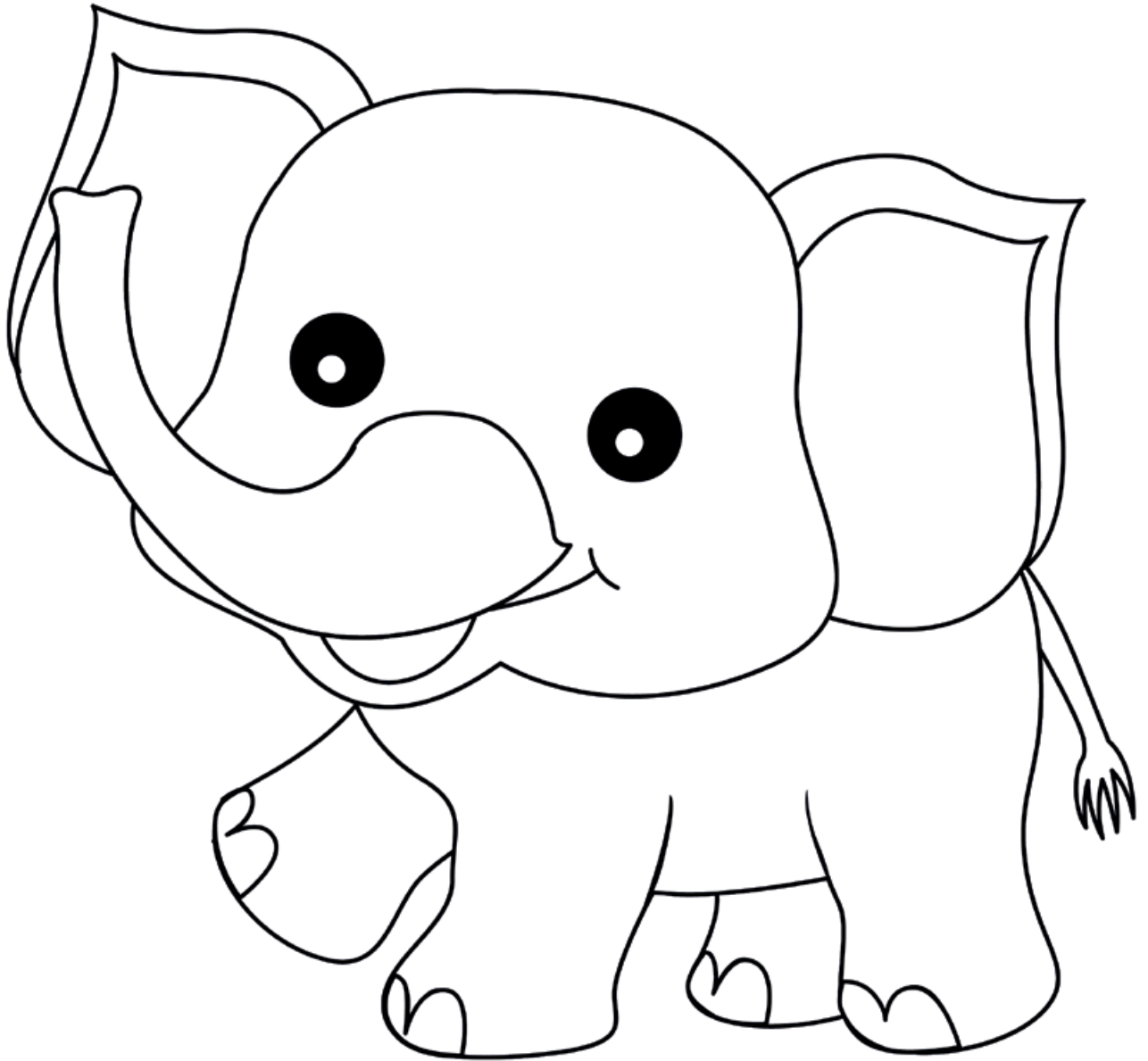

Kleur in volgens die syfers

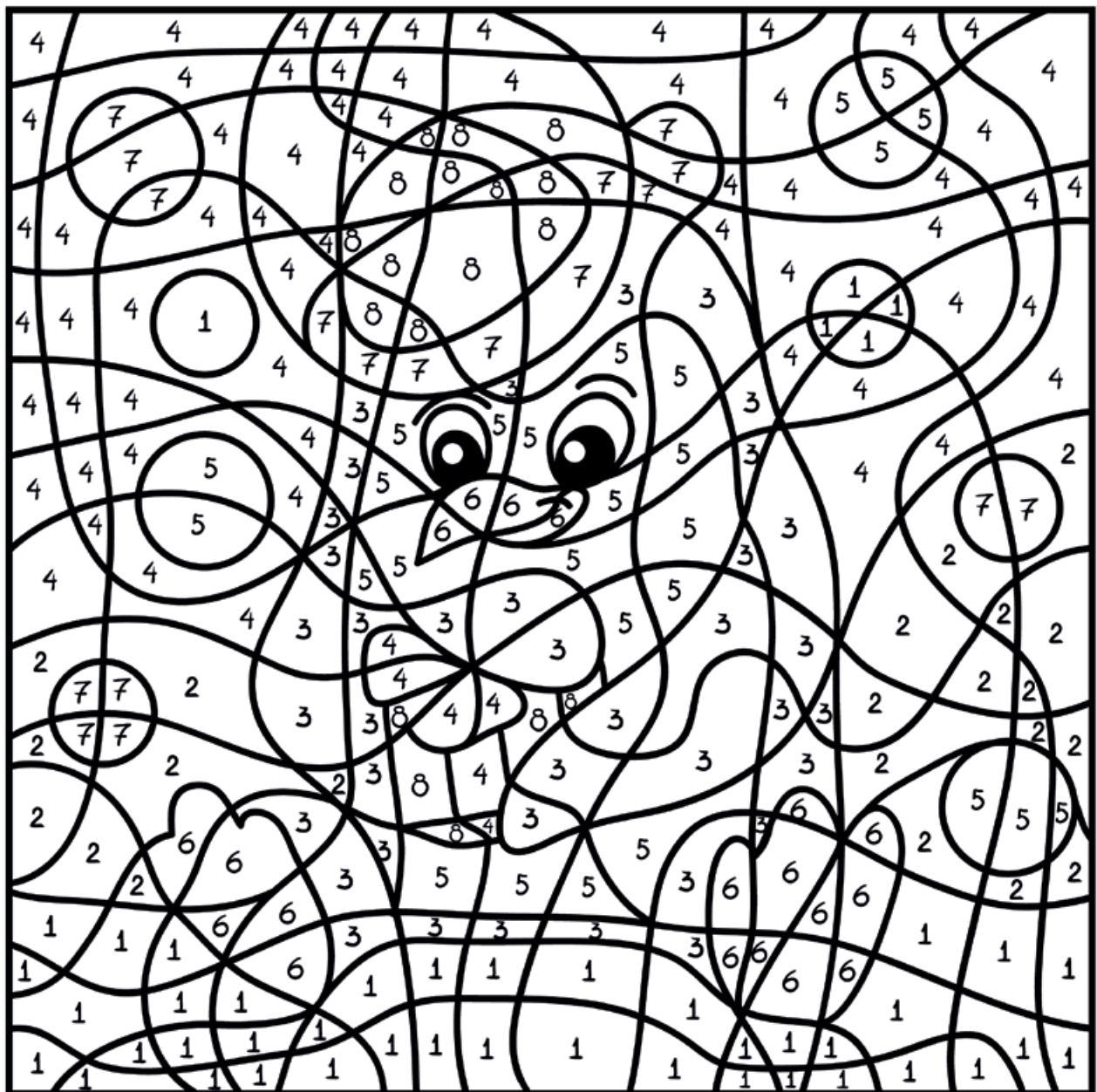

1 - ligblou 2 - blou 3 - swart 4 - donkerblou
5 - geel 6 - oranje 7 - pienk 8 - rooi

Pas bymekaar

2

.

.

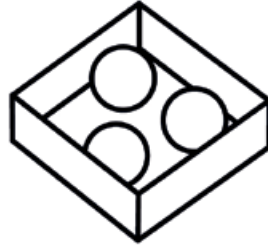

3

.

.

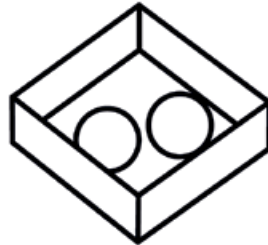

4

.

.

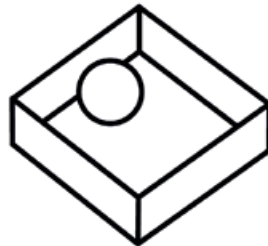

1

.

.

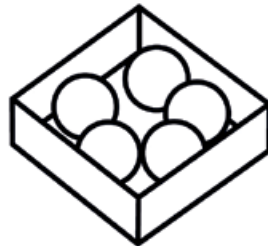

5

.

.

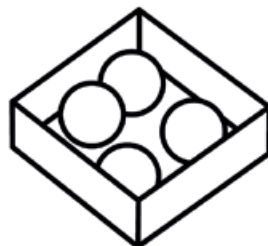

Kol tot kol

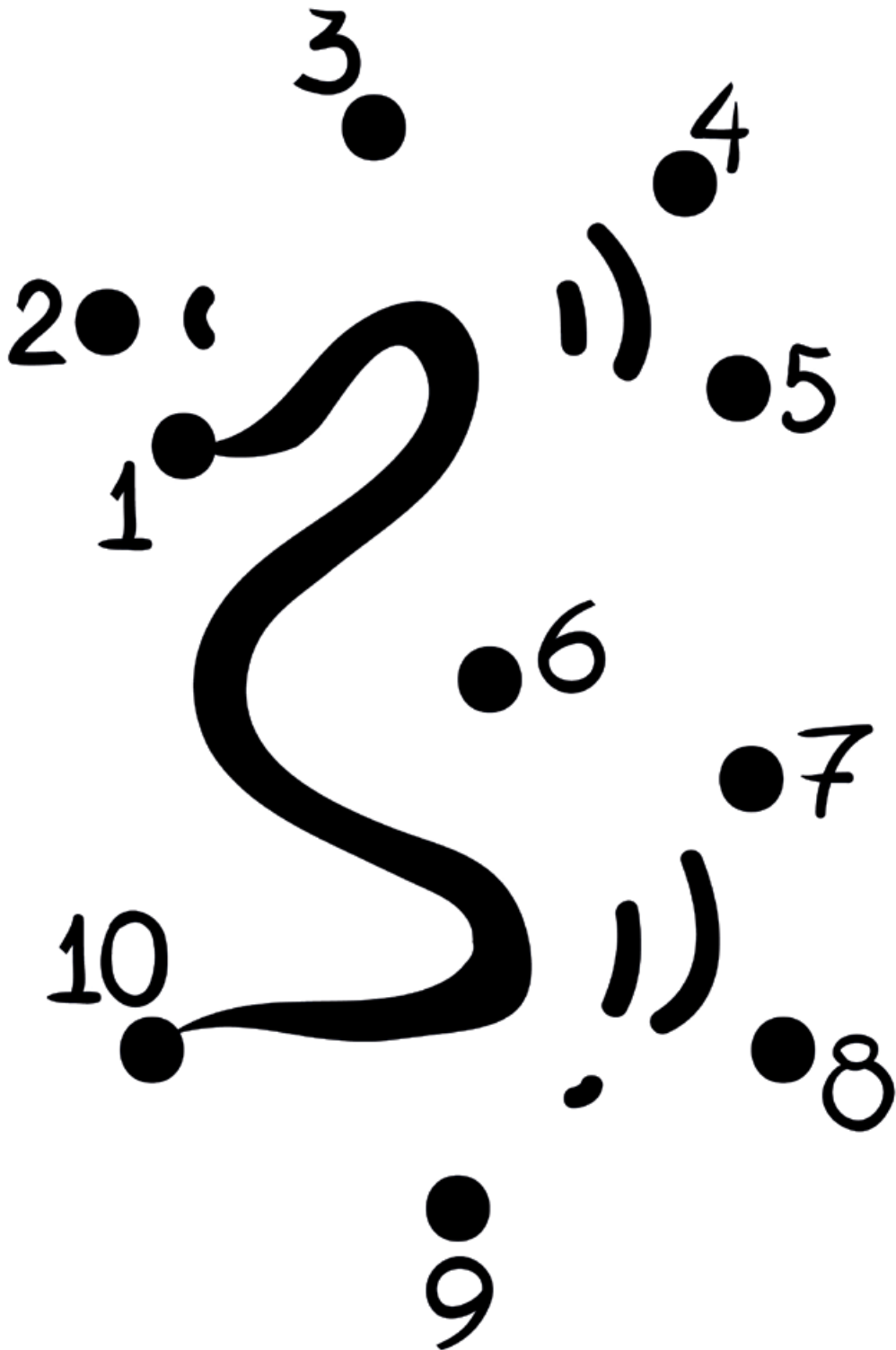

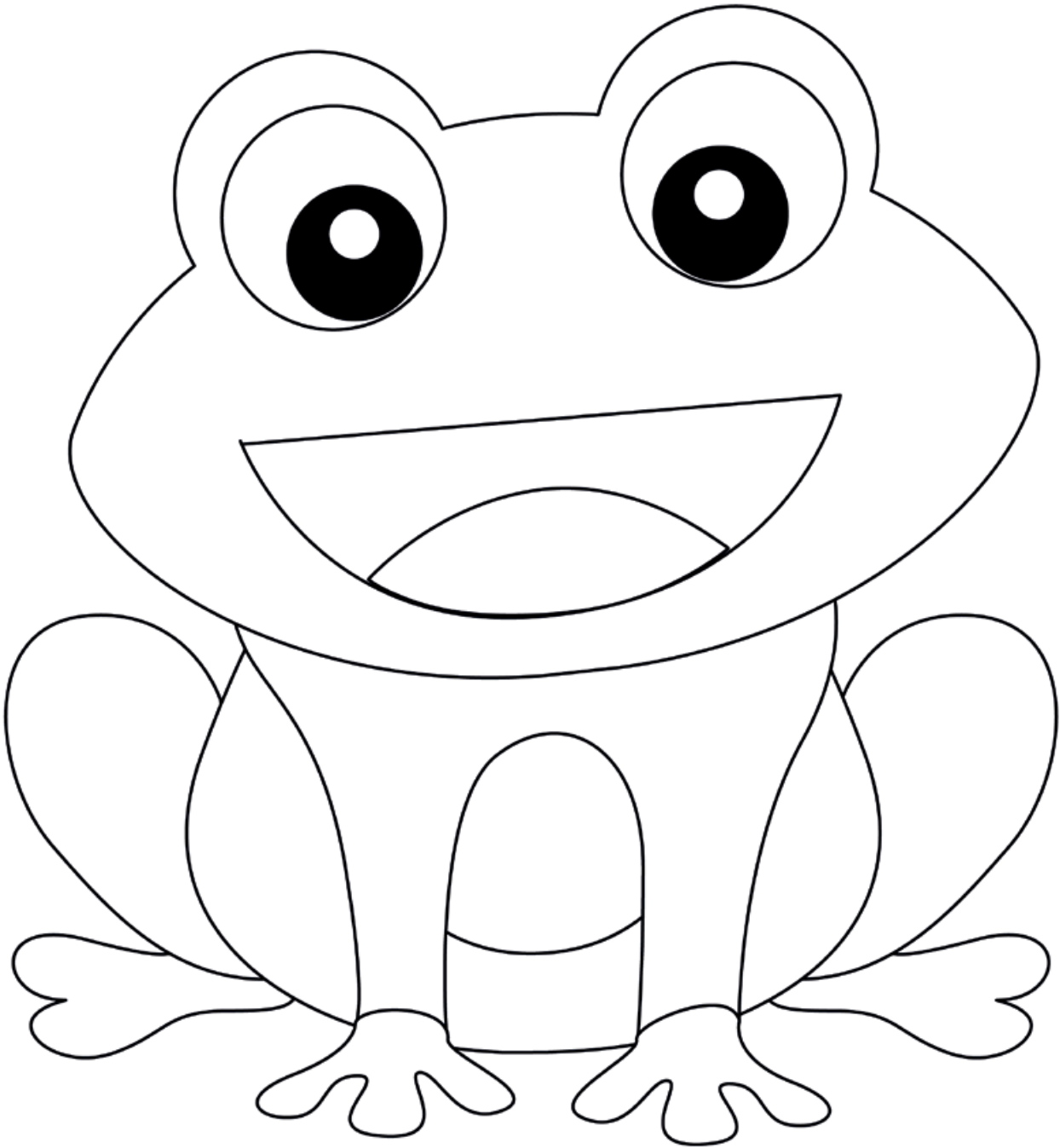

Kleur in volgens die syfers

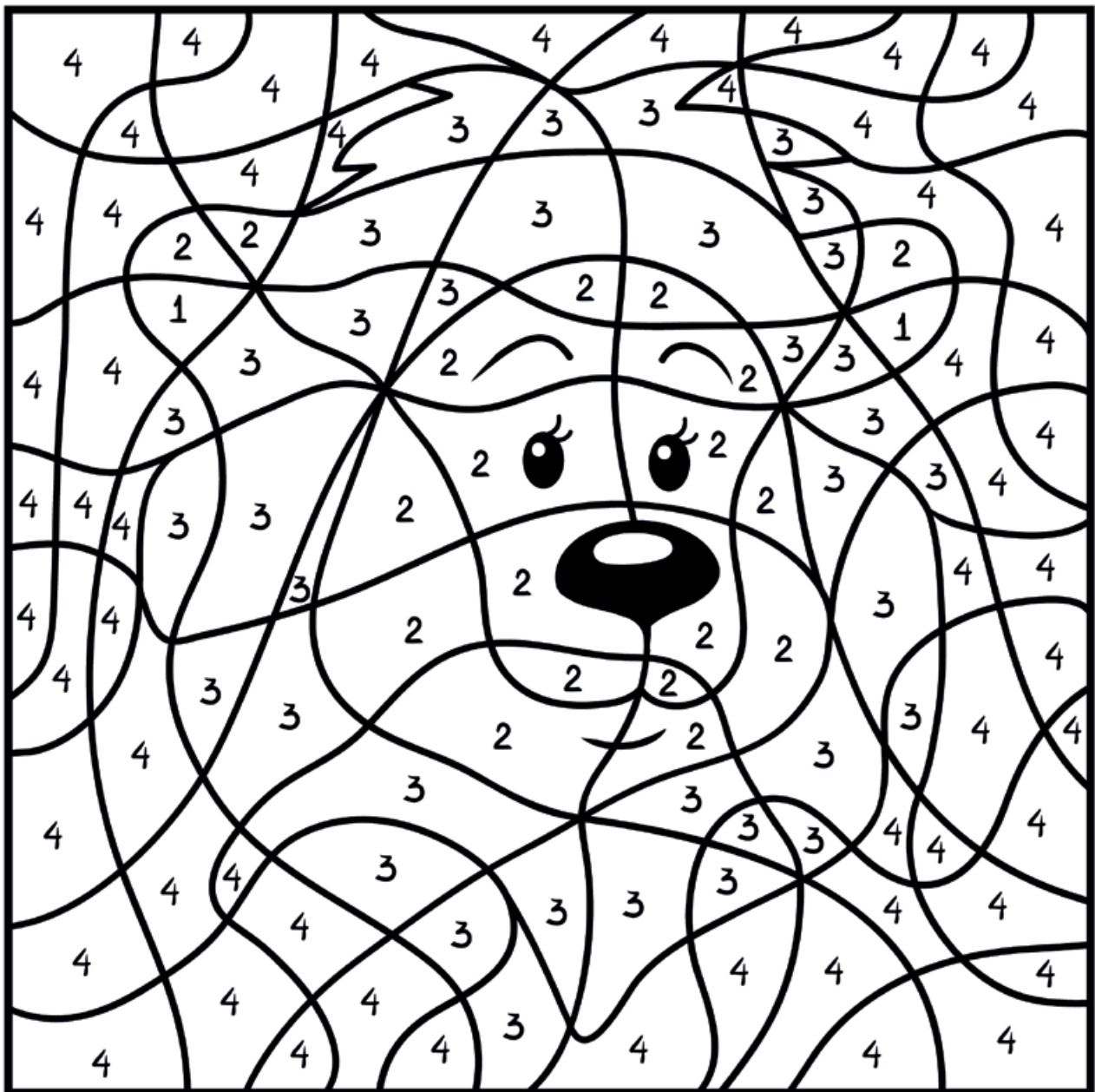

1 - pienk 2 - geel 3 - bruin 4 - groen

Oefen om te teken

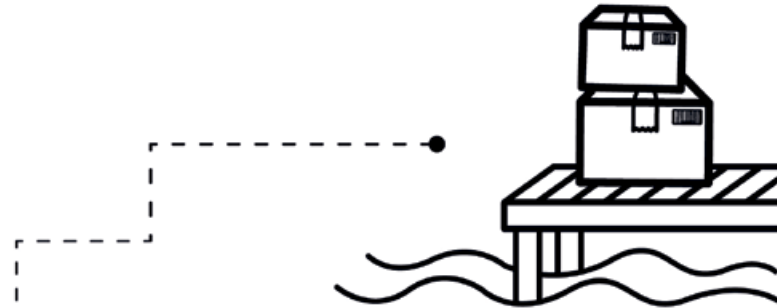

Kol tot kol

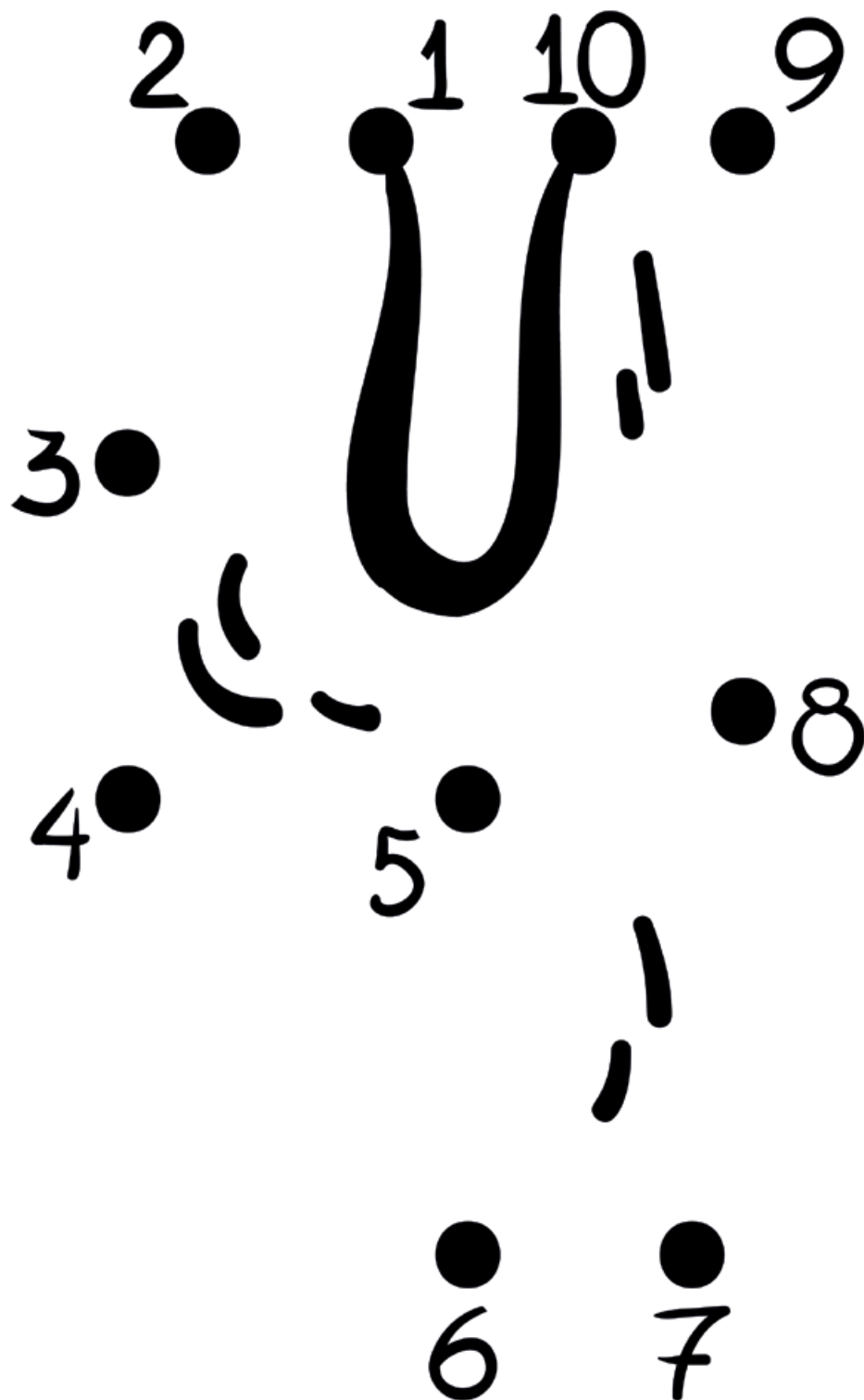

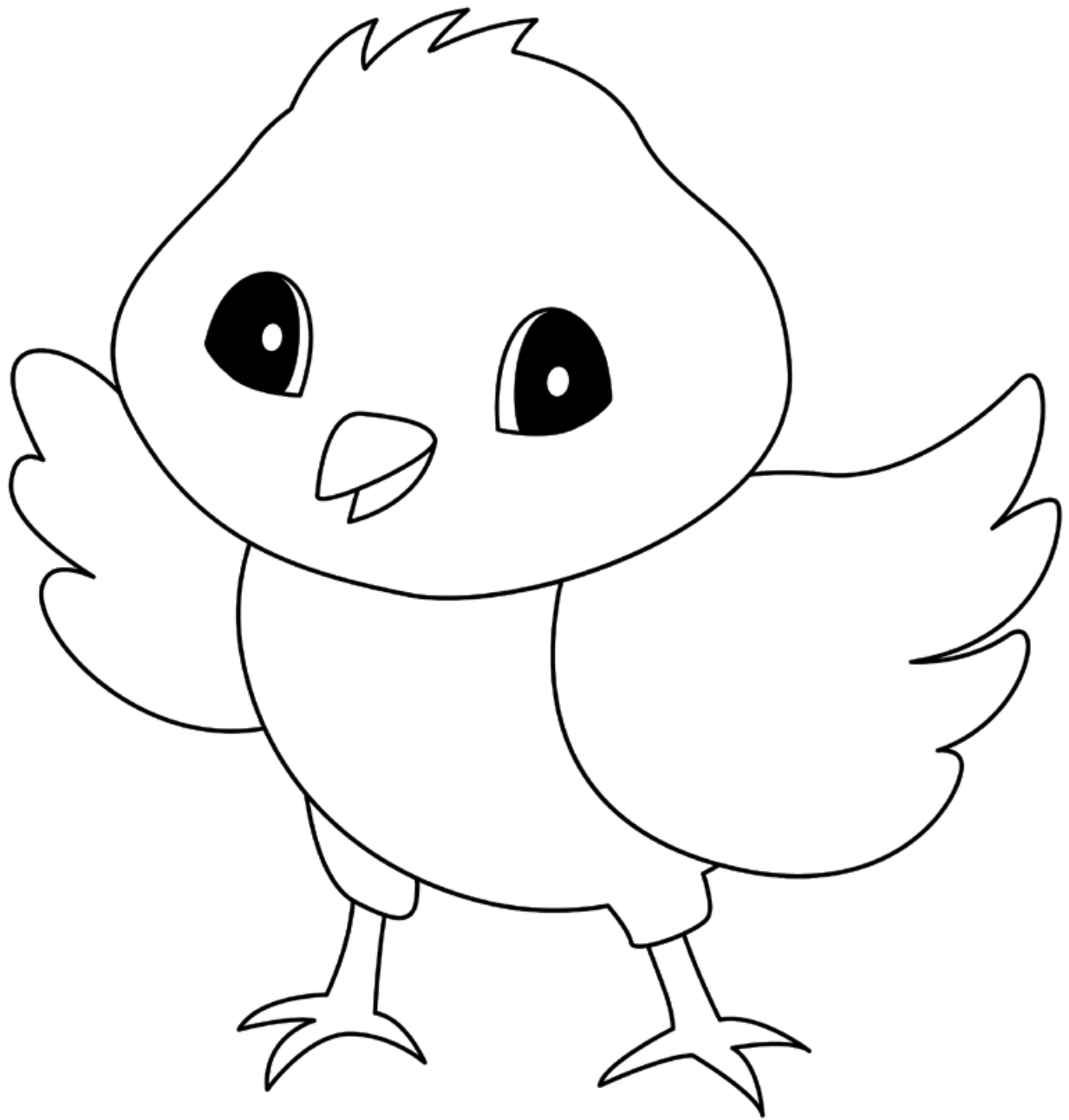

Kleur in volgens die syfers

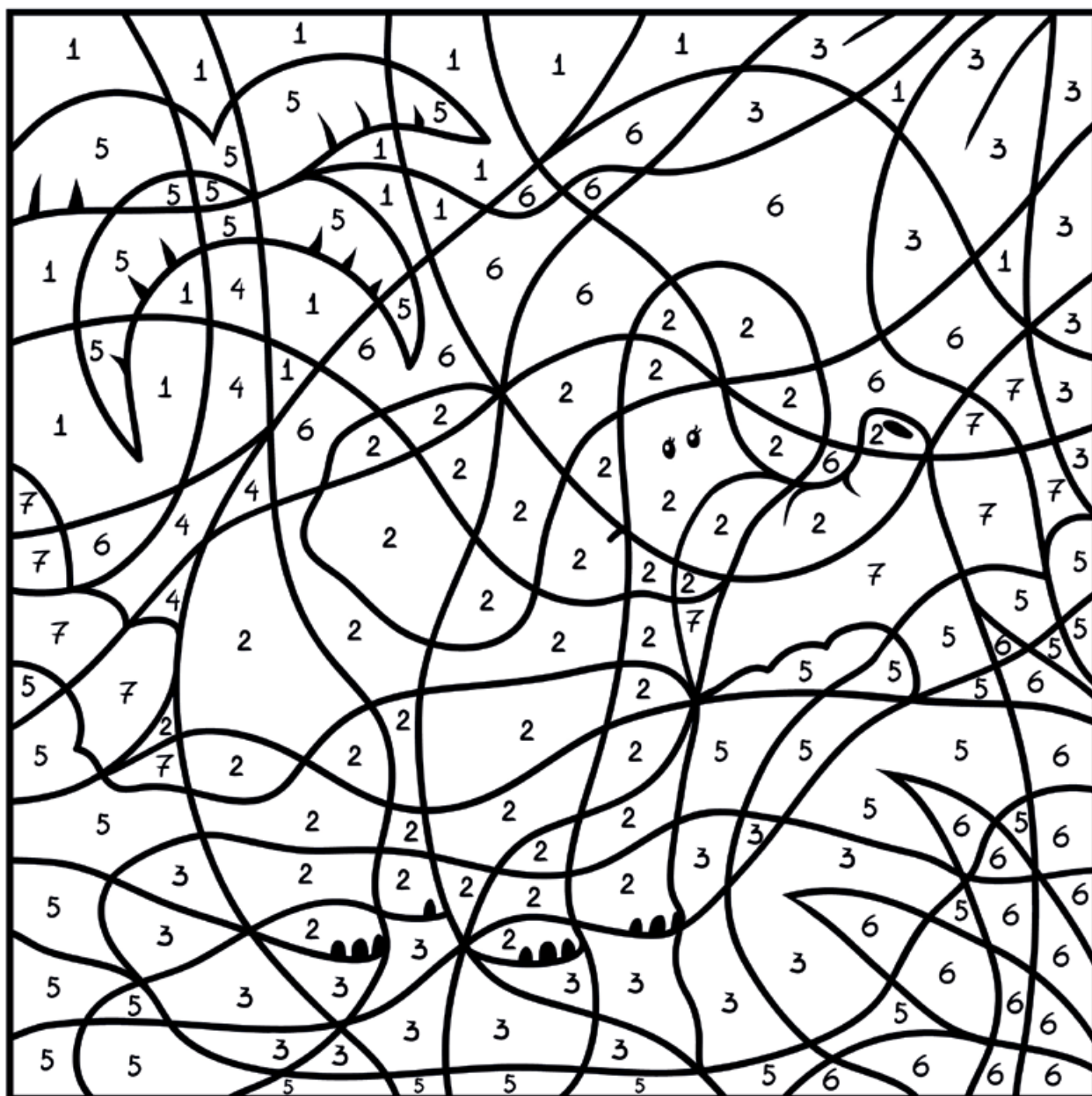

1 - ligblou 2 - grys 3 - geel 4 - oranje
5 - liggroen 6 - groen 7 - donkergroen

Hoeveel?



Kol tot kol

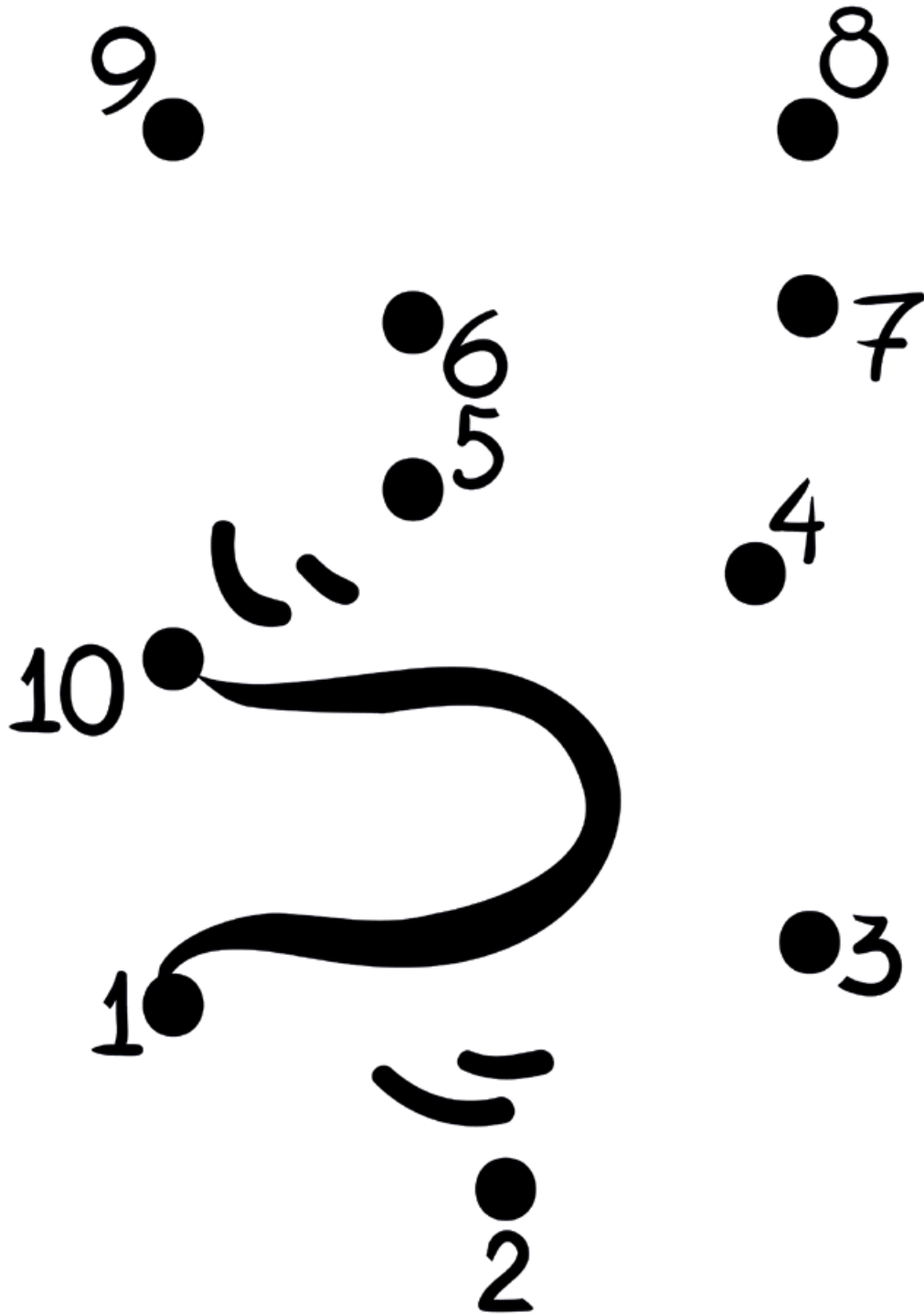

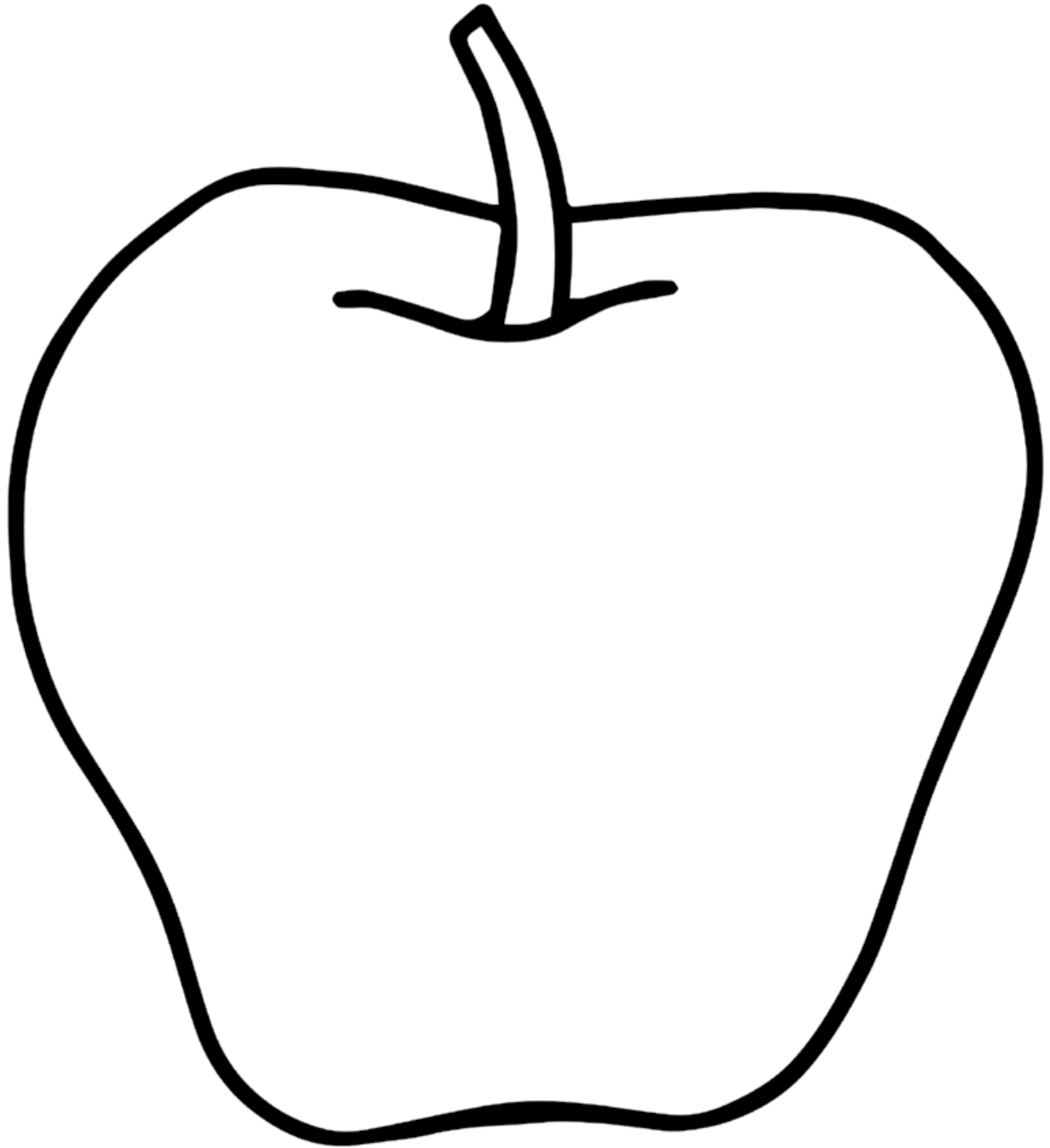

Kleur in volgens die syfers

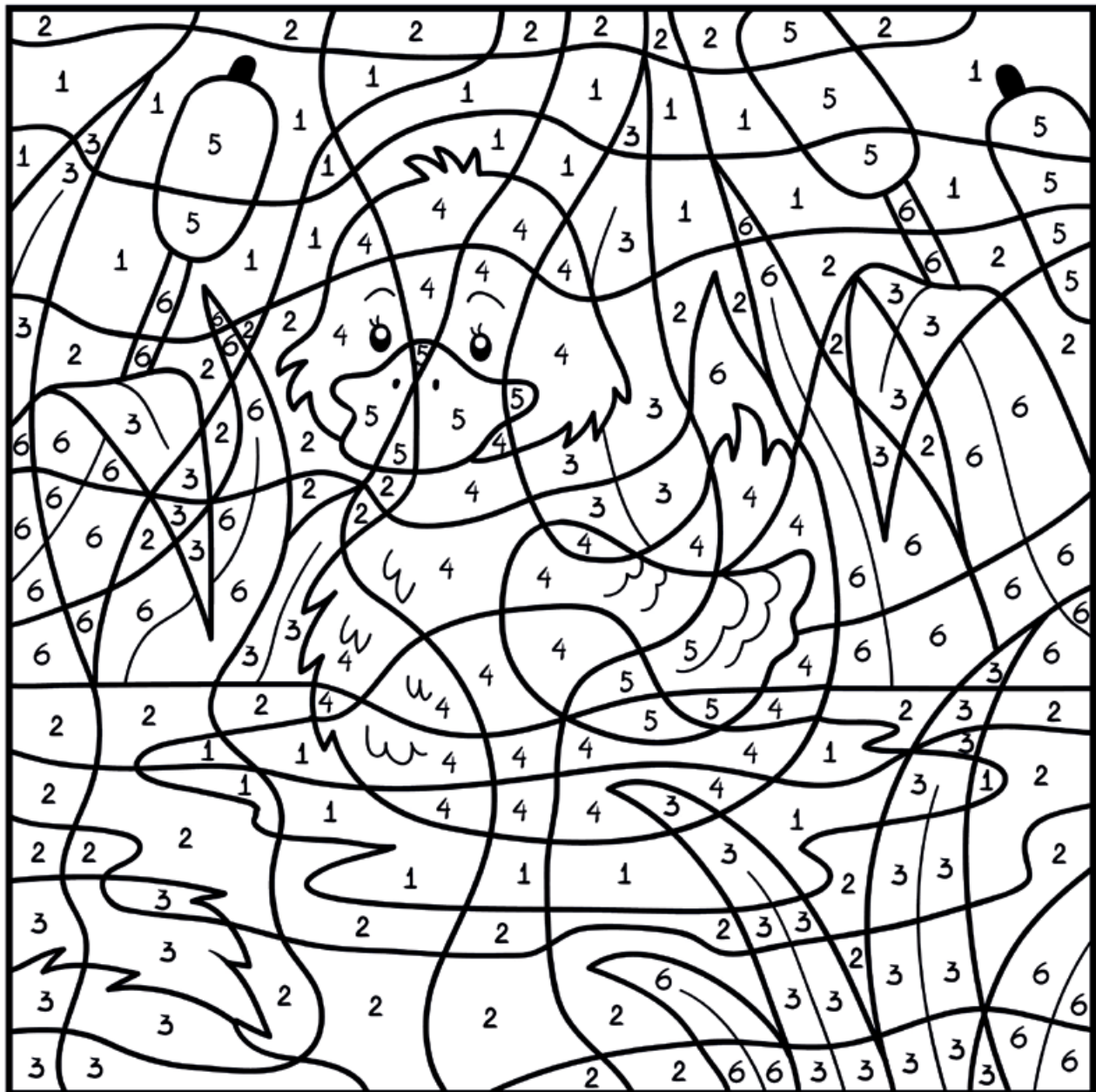

1 - ligblou 2 - blou 3 - groen 4 - geel
5 - oranje 6 - donkergroen

Soek 5 verskille



Kol tot kol

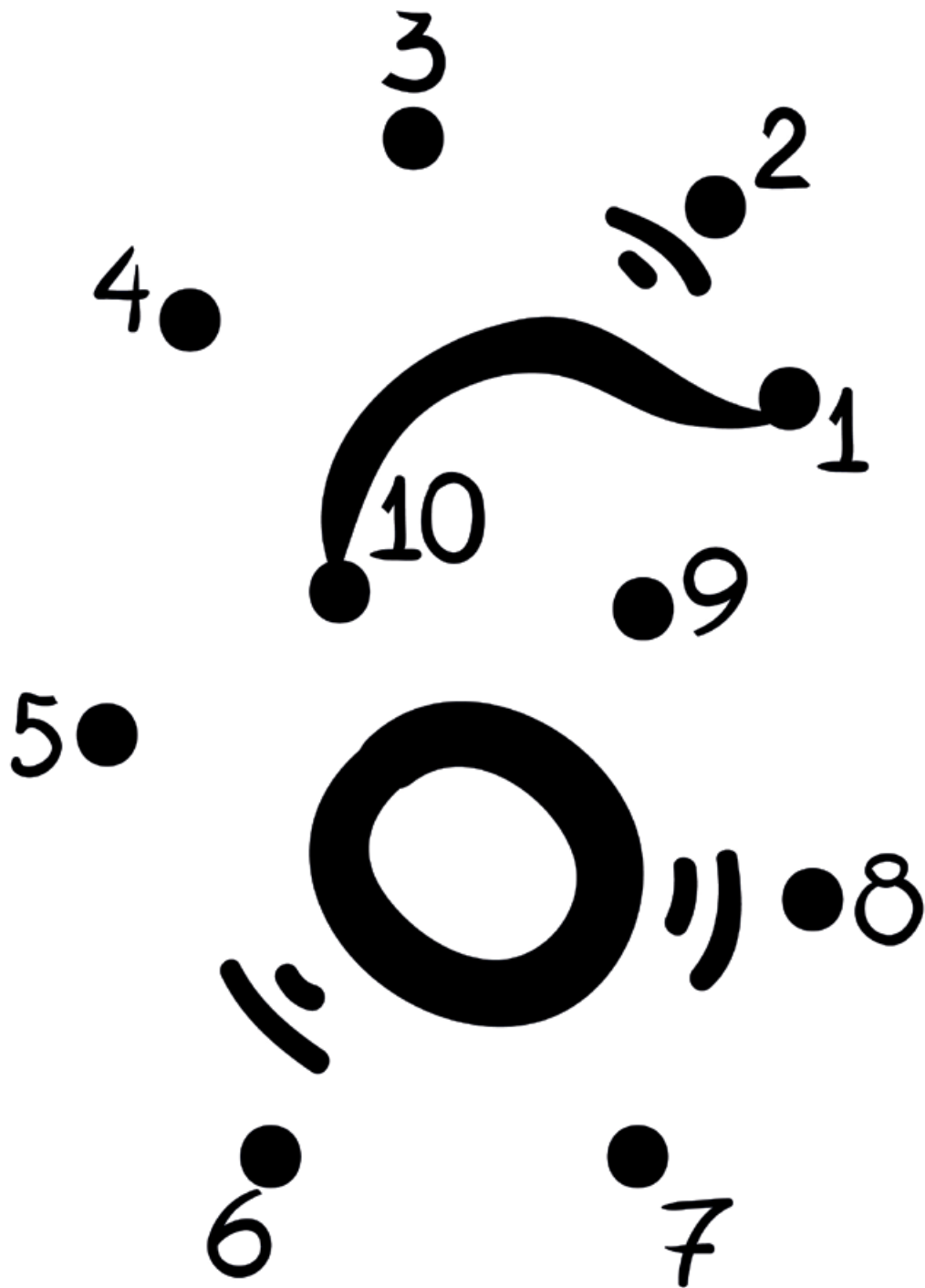

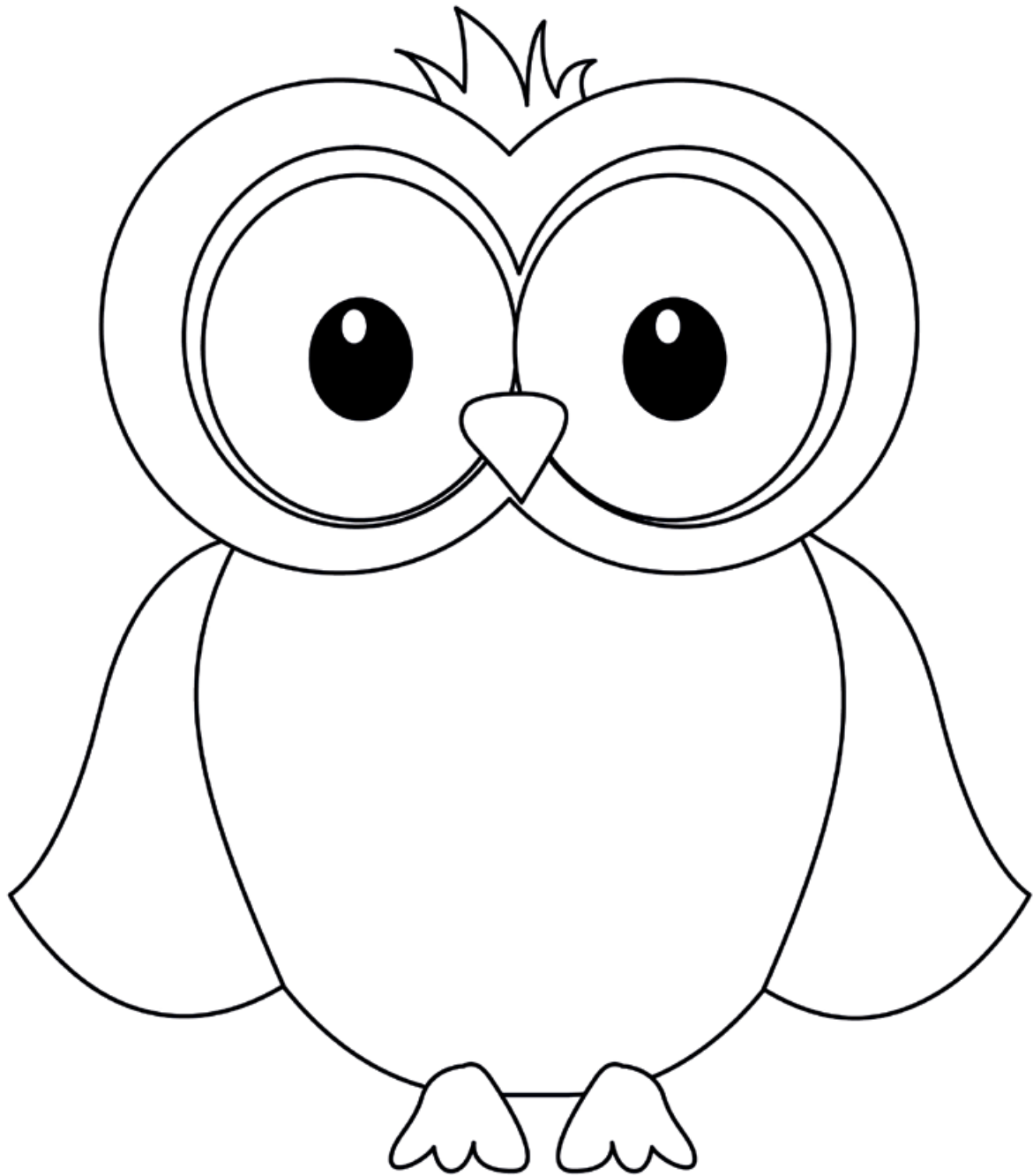

Kleur in volgens die syfers



1 - donkergroen 2 - bruin 3 - ligblou 4 - groen
5 - swart 6 - grys 7 - geel 8 - rooi 9 - pienk

Oefen om te tel

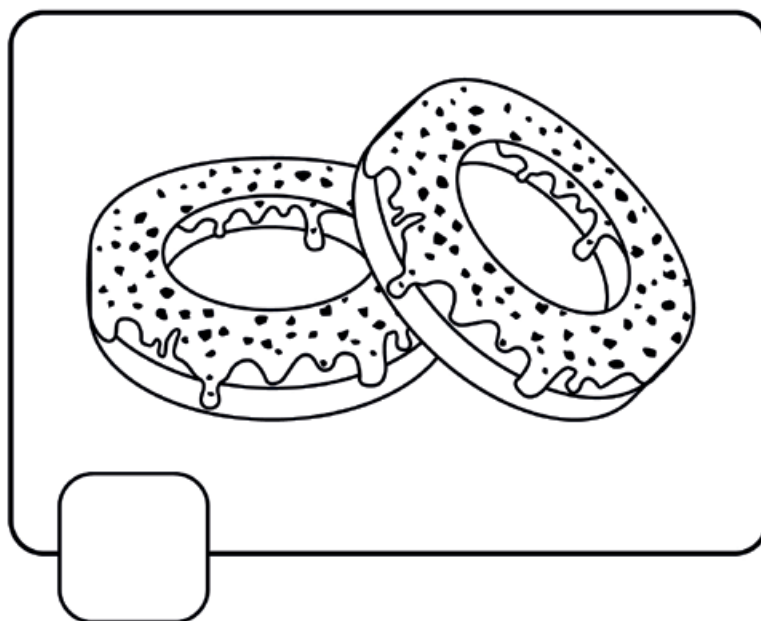
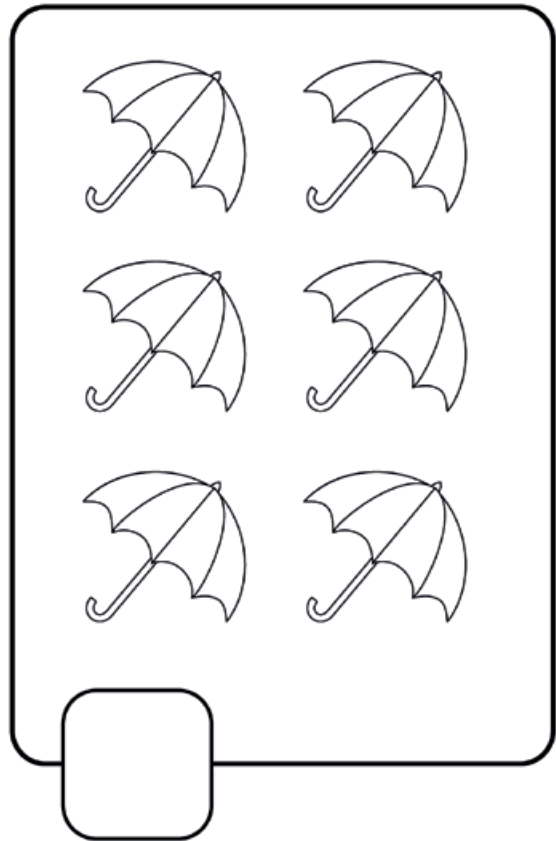
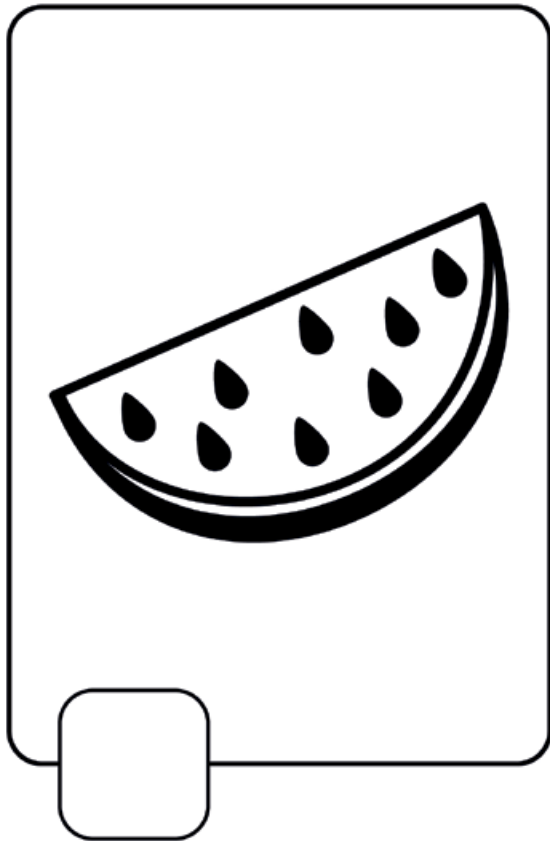

Kol tot kol

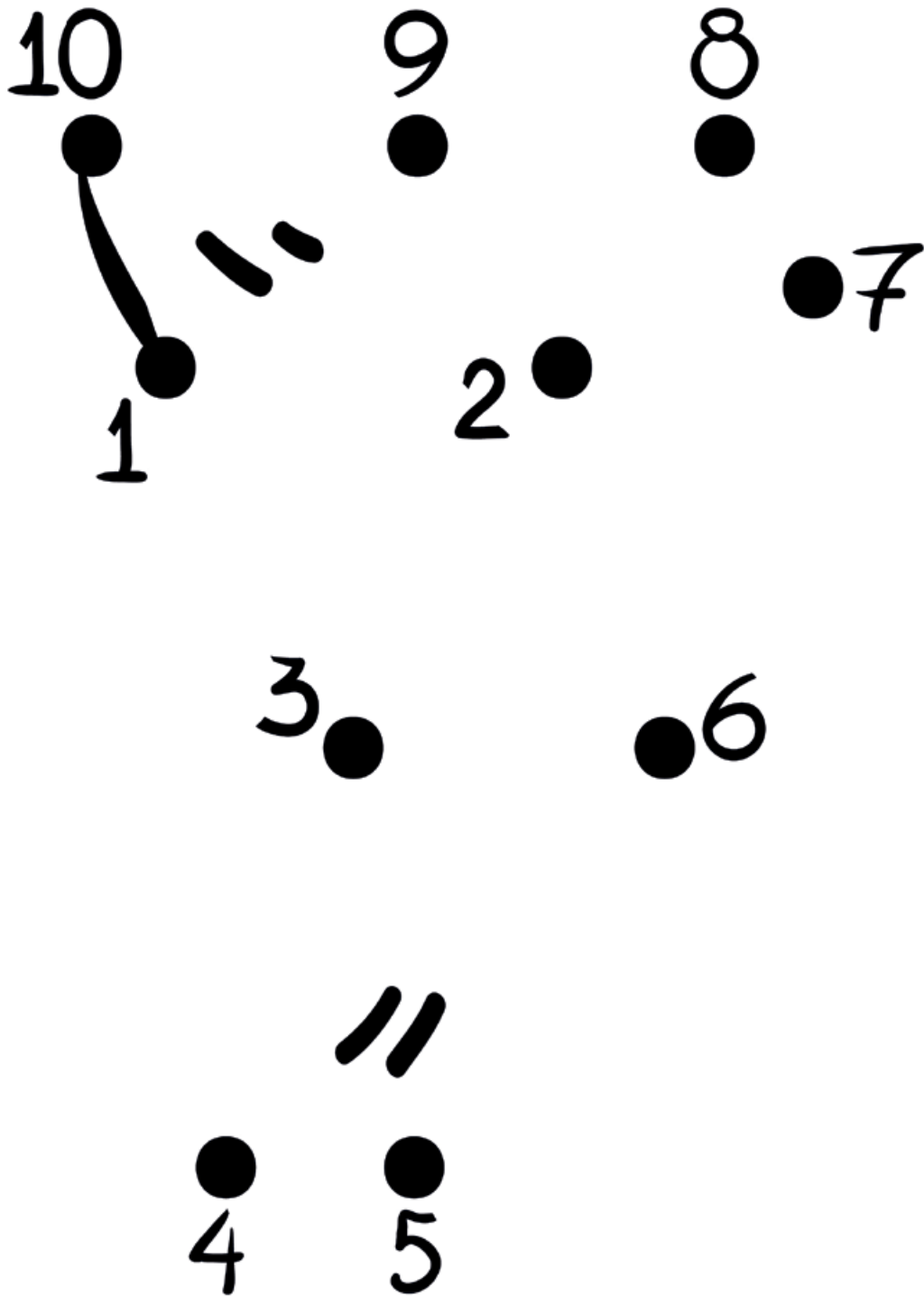

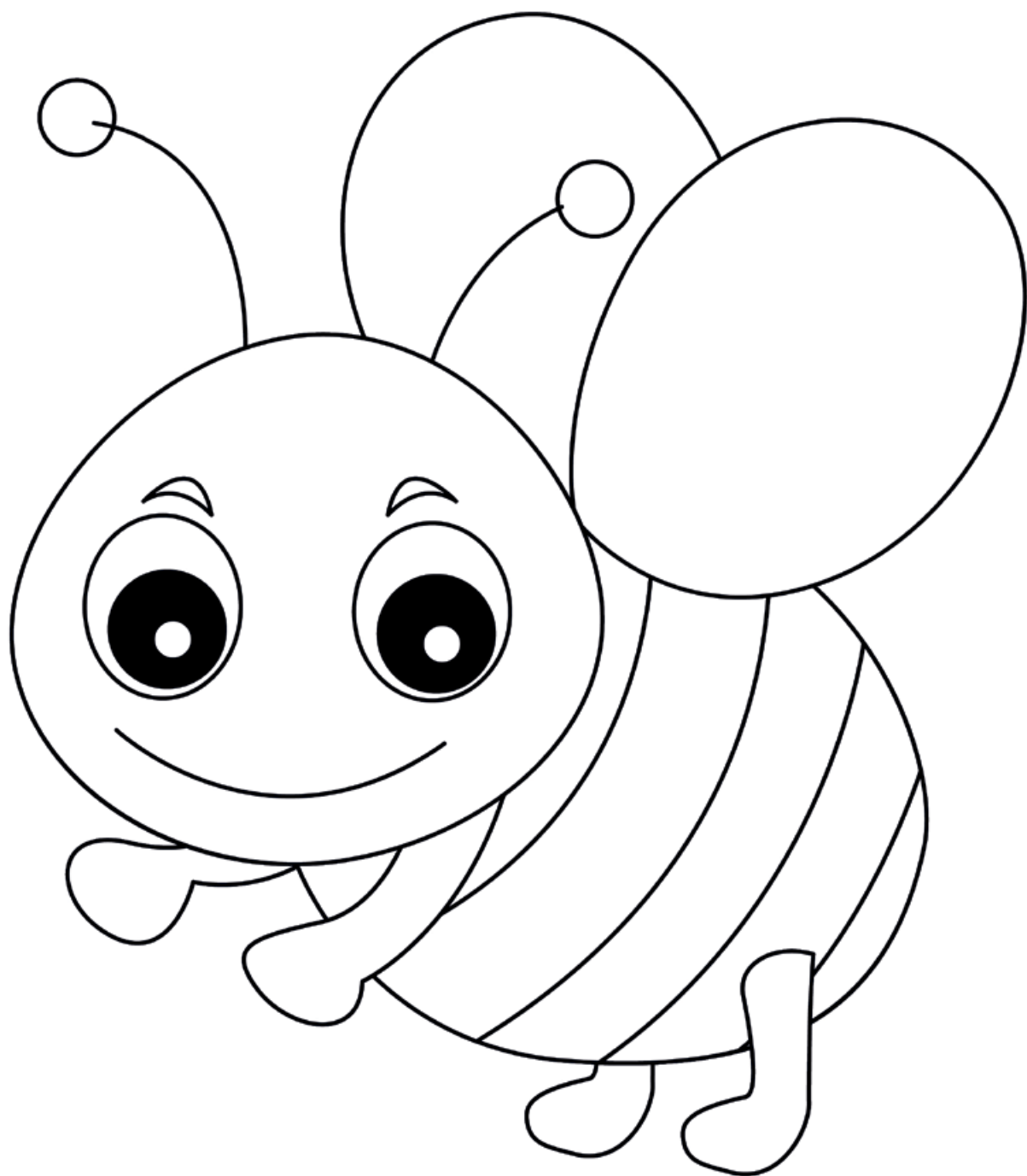

Kleur in volgens die syfers

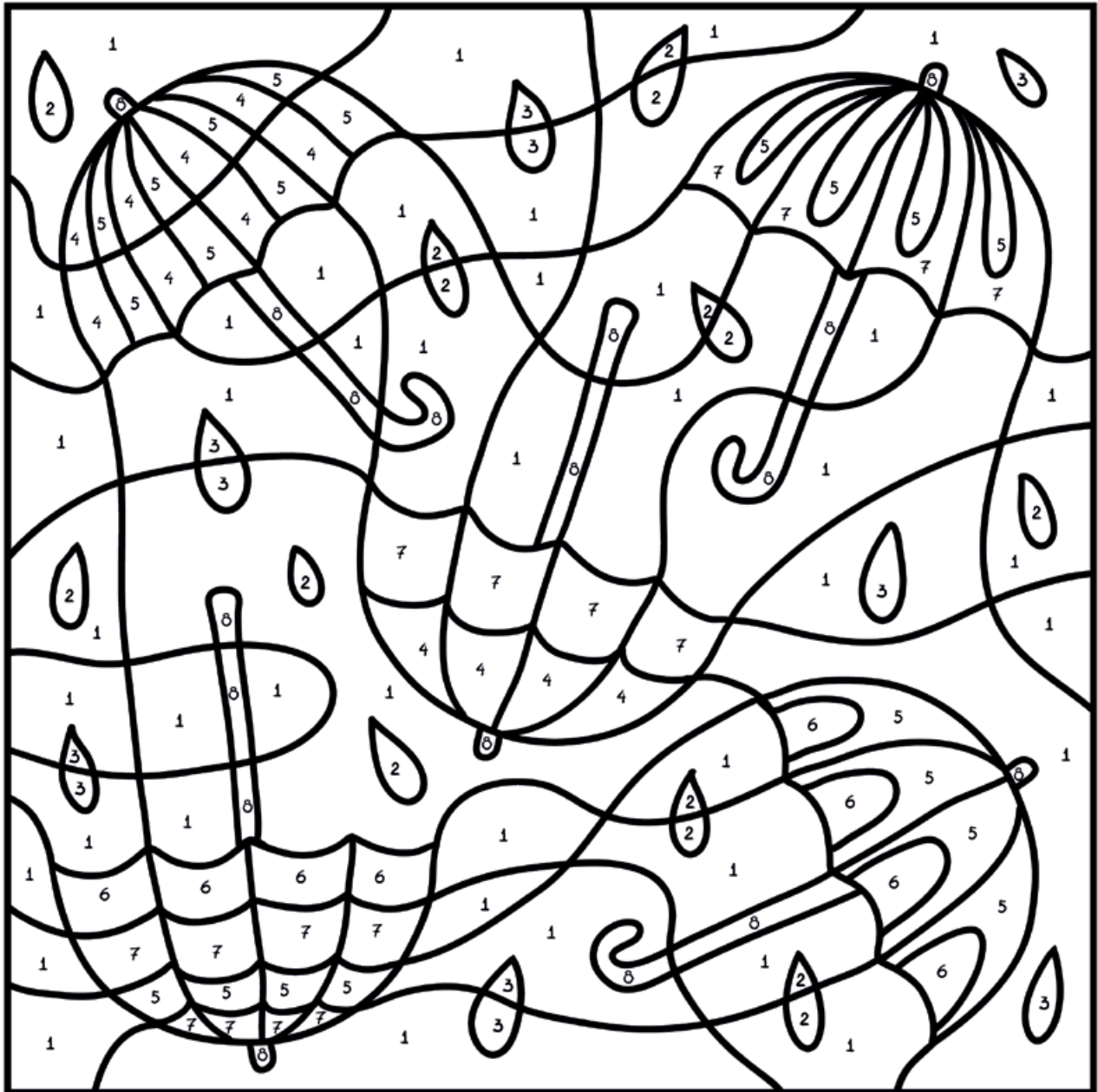

1 - swart 2 - ligblou 3 - blou 4 - groen
5 - geel 6 - rooi 7 - oranje 8 - pers

Pas bymekaar

4

.

.



8

.

.



5

.

.



6

.

.



7

.

.



Kol tot kol

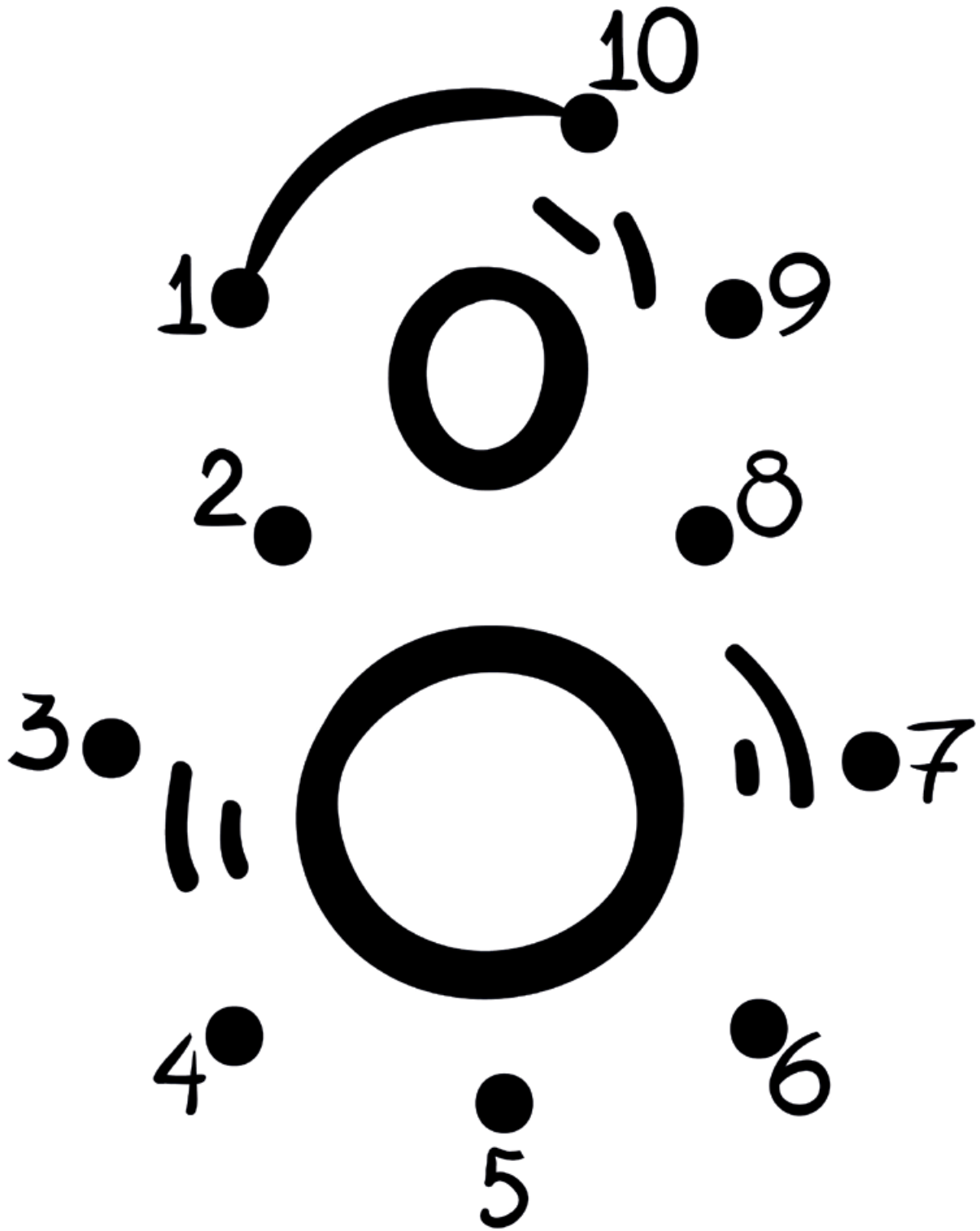

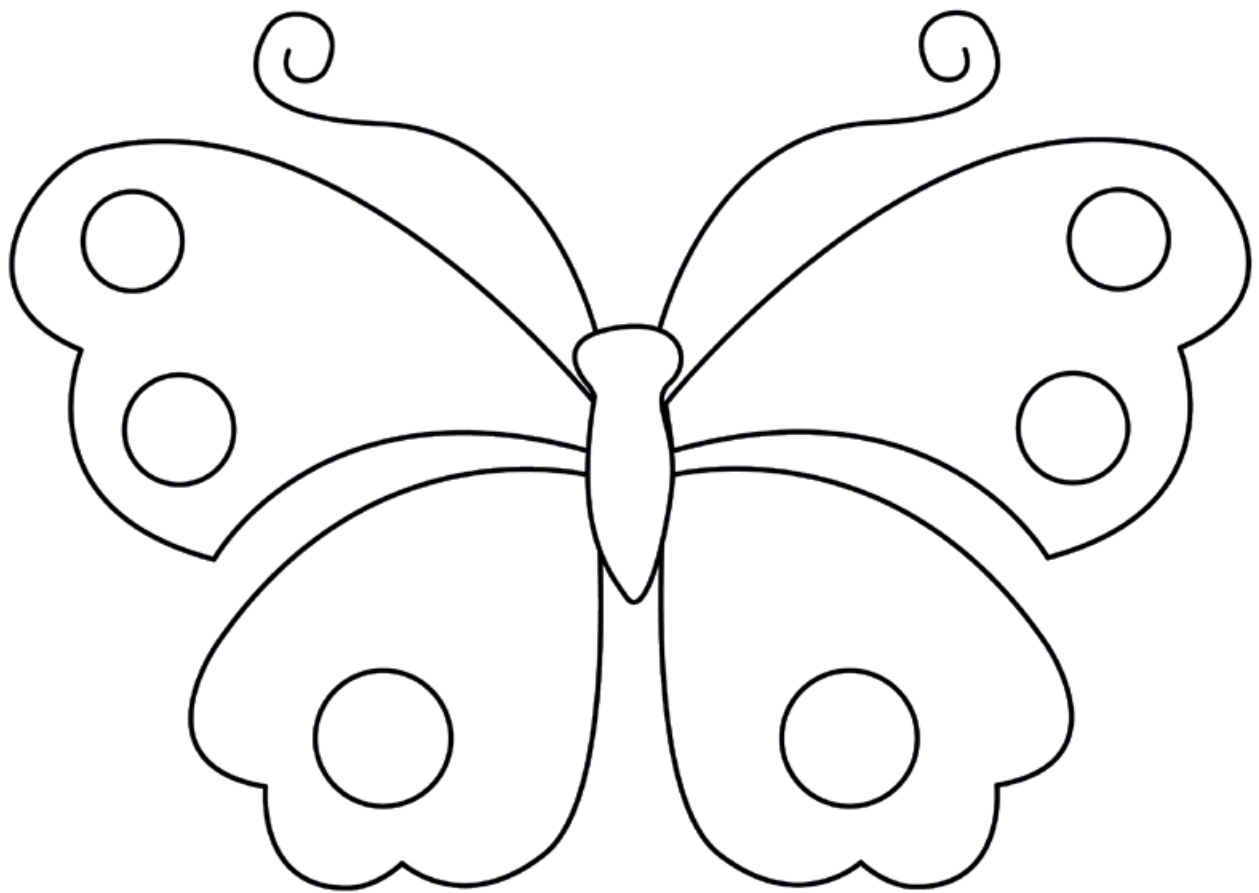

Kleur in volgens die syfers



1 - groen 2 - donkergroen 3 - ligblou 4 - oranje
5 - bruin 6 - blou 7 - beige

Oefen om te tel

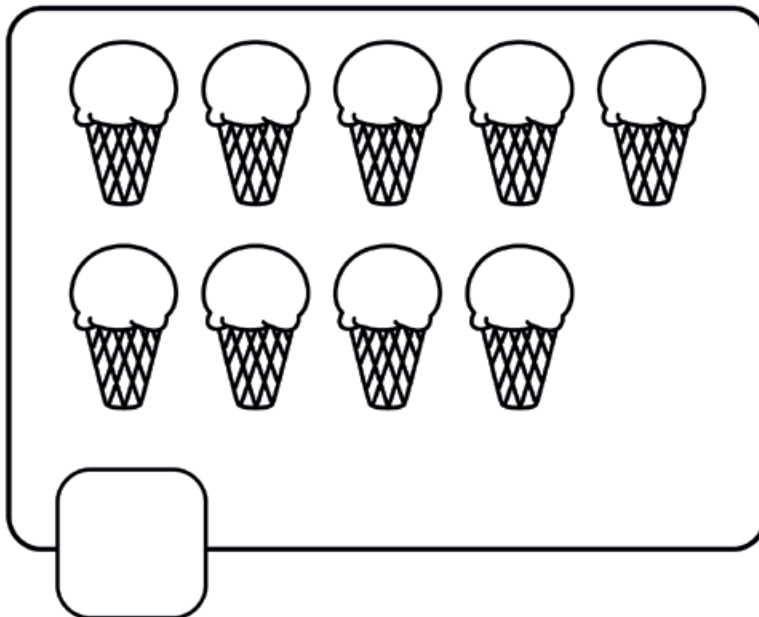
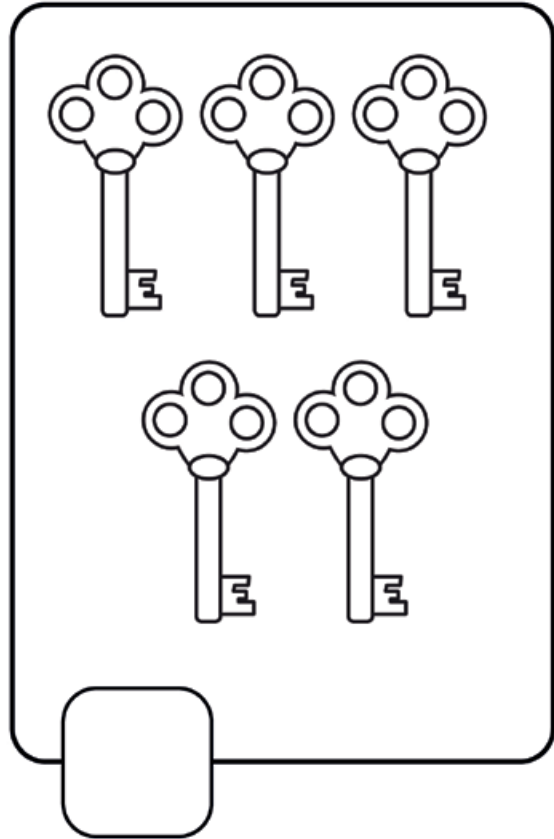

Kol tot kol

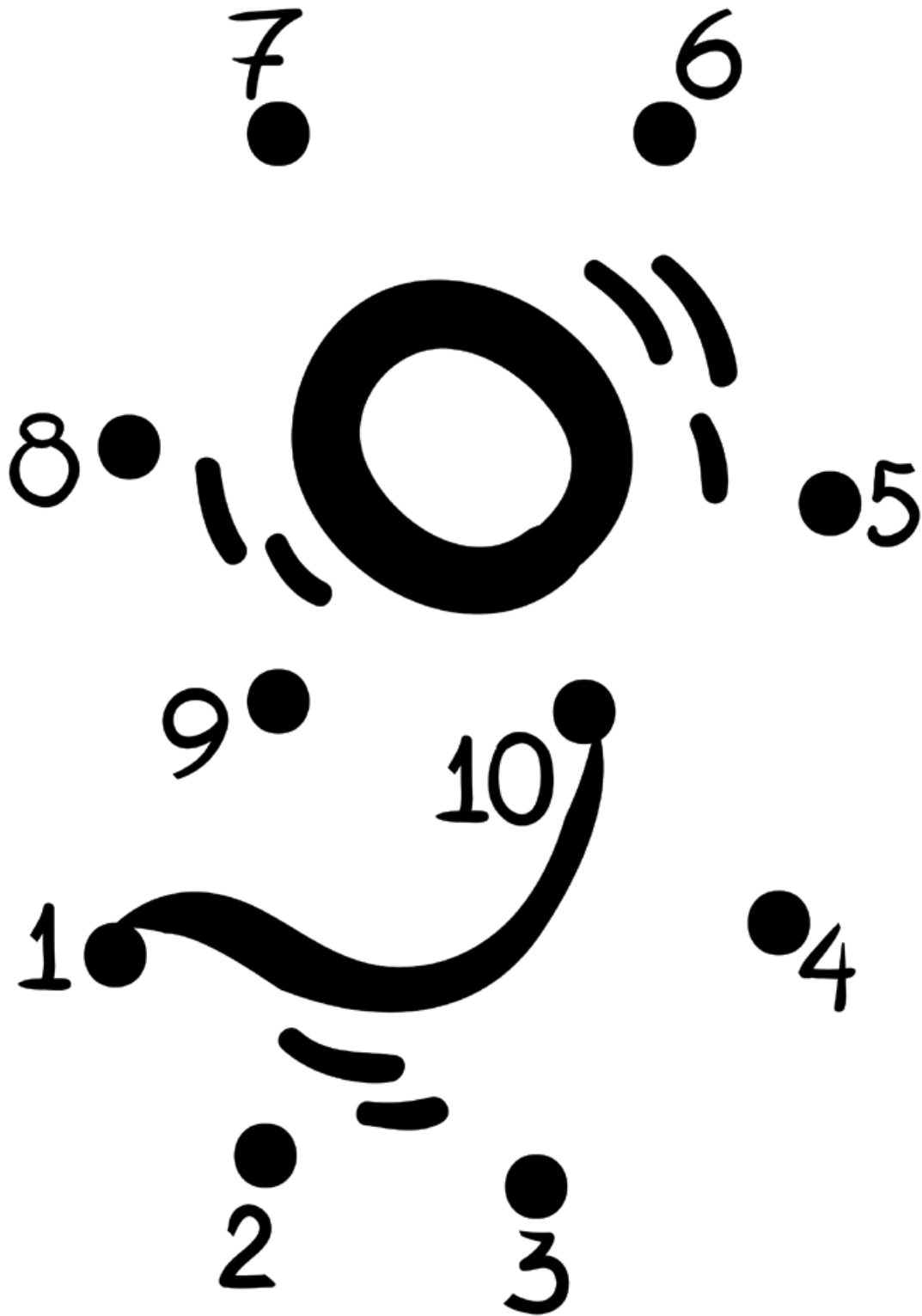

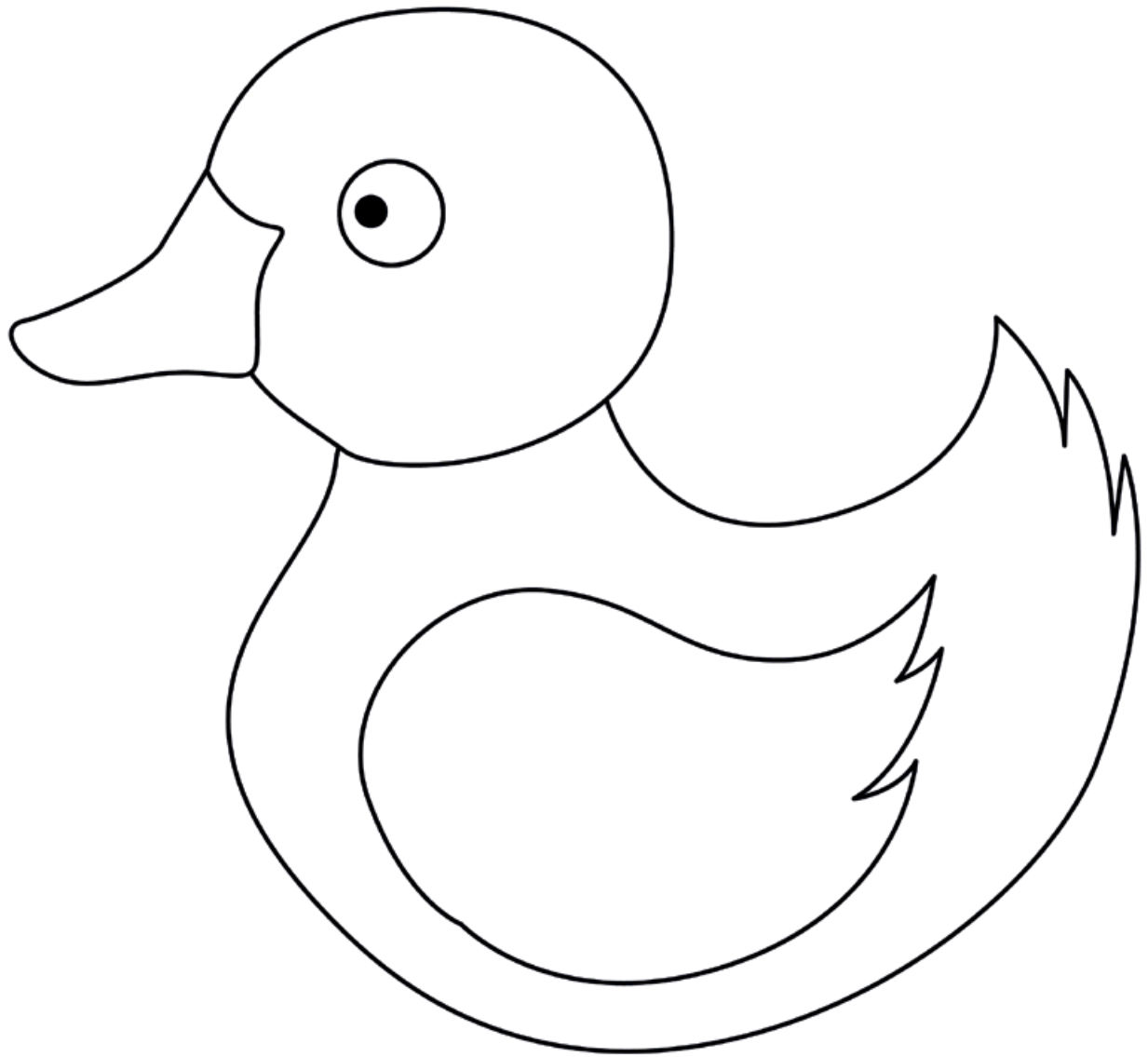

Kleur in volgens die syfers



1 - rooi 2 - ligblou 3 - geel 4 - gryswart 5 - swart
6 - beige 7 - pienk 8 - groen 9 - donkergroen

Kol tot kol

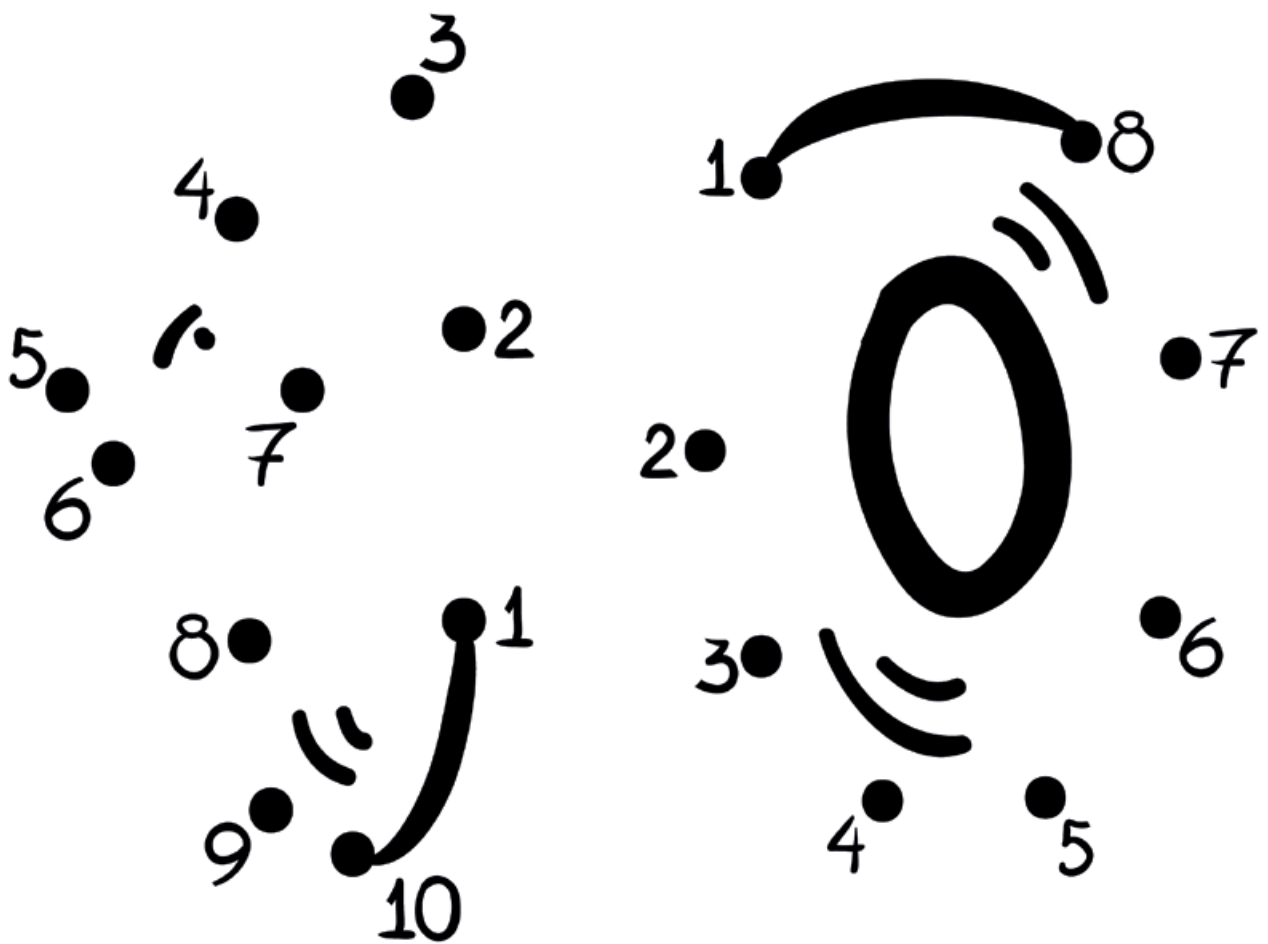

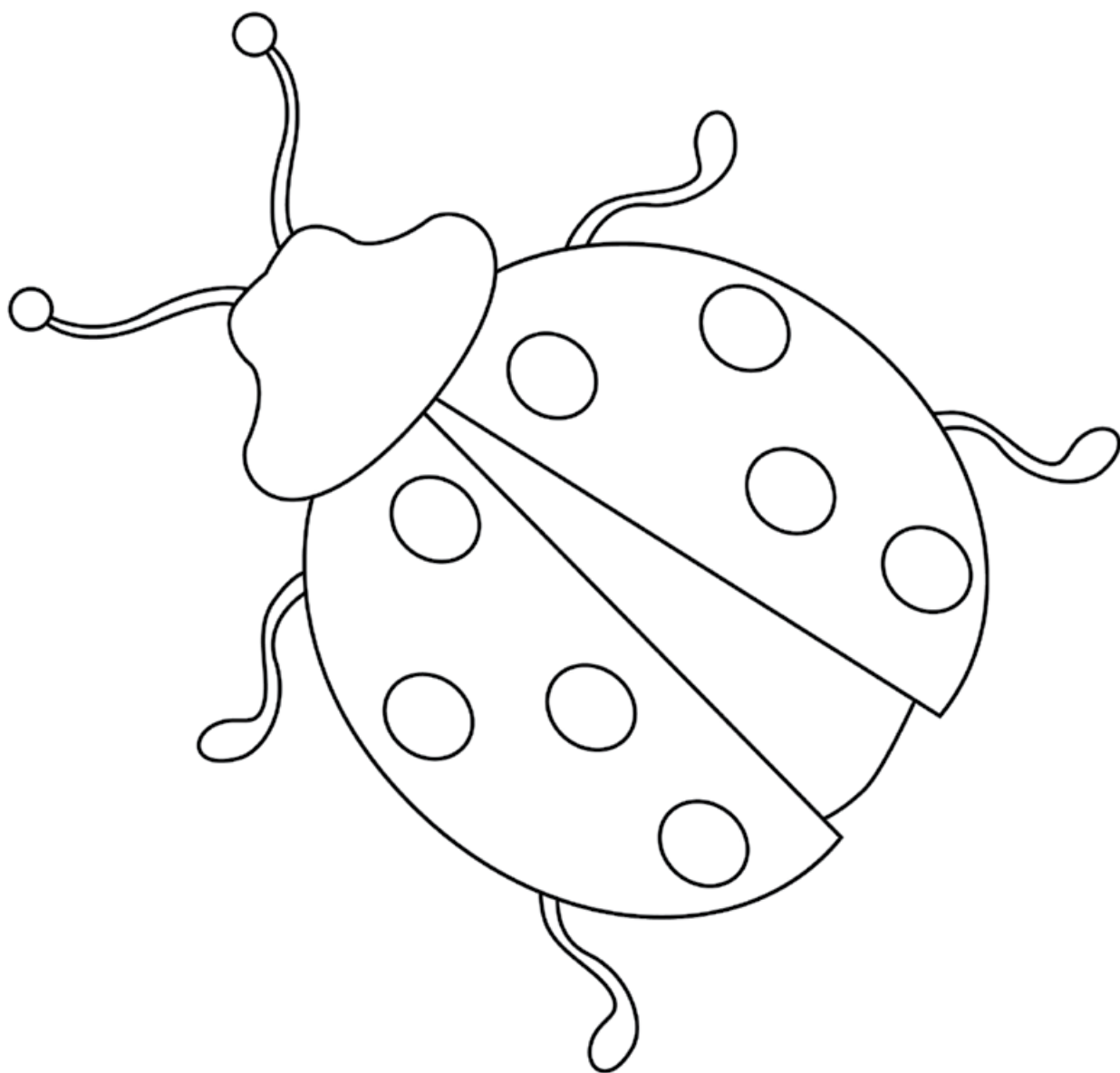

Kleur in volgens die syfers

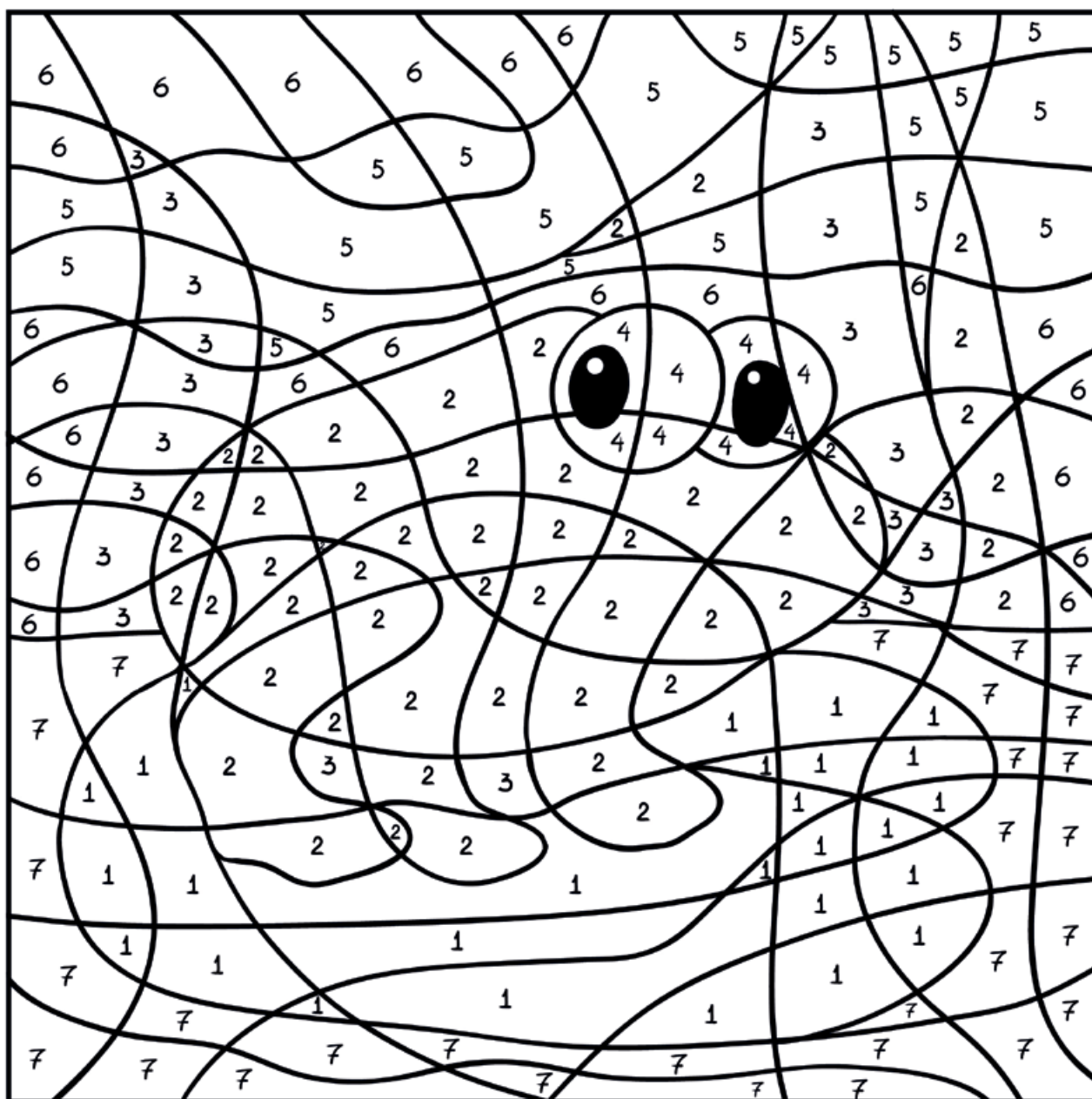

1 - liggroen 2 - groen 3 - donkergroen
4 - wit 5 - ligblou 6 - blou 7 - donkerblou

Oefen om te tel

1	2	...	4	...	6
7	10
...	14	17	...
19	22	...	24
25	29	...